



CREATE  
YOUR  
HOME

MADE IN ITALY



2021  
2022  
COLLECTIONS

# MUNARI SINCE 1977



I fratelli Munari fondarono nel 1977 a Ca' degli Oppi in provincia di Verona (Italia) la loro fabbrica.

Munari è attualmente produttore di mobili di design dedicati alle aree living e ingresso, con alta specializzazione nei mobili TV identificati dal mercato per le uniche soluzioni tecniche e stilistiche.

Oggi Munari è un brand riconosciuto in Italia ed Europa con posizionamento medio-alto nel proprio settore.

Les frères Munari ont fondé leur usine à Ca' degli Oppi dans la province de Verona (Italy) en 1977.

Munari est actuellement un fabricant de mobilier design dédié au salon et à l'entrée, avec un haut degré de spécialisation dans le mobilier TV identifié par le marché pour ses solutions techniques et stylistiques uniques.

Aujourd'hui, Munari est une marque reconnue en Italie et en Europe avec un positionnement moyen-élevé dans son secteur.

Los hermanos Munari fundaron su fábrica en Ca' degli Oppi en la provincia de Verona (Italy) en 1977.

Munari es actualmente productor de muebles, dedicado expresamente al diseño de salas de estar y entradas. Presenta una alta especialización en muebles para la televisión, los cuales son identificados por el mercado como las únicas soluciones técnicas y estilísticas.

## QUALITY & DETAILS



## WE ARE MADE IN ITALY



# CREATE YOUR HOME

MODENA

Pag. 08 - 15



TV cabinet - Groundstyle



TV cabinet - Feetstyle

MODENA

Pag. 16 - 19



Living - Groundstyle



Living - Wallstyle

MODENA

Pag. 20 - 21

Pag. 22 - 27



Living - Freestyle



Entrance - Entreestyle



# COLLECTIONS

MO&MA

Pag. 30 - 35



TV cabinet - Groundstyle



TV cabinet - Feetstyle

MO&MA

Pag. 36 - 37

Pag. 38 - 39



TV cabinet - Wallstyle



Living - Freestyle

RAVENNA

Pag. 40 - 45



TV cabinet - Groundstyle



TV cabinet - Feetstyle

# COLLEZIONE MODENA

Design by Eros Angelini

In affinità elettiva abbiamo voluto dedicare a questa città la collezione Munari: MODENA, quale madre dei più prestigiosi marchi di automobili, capaci di produrre design e tecnologia come fa oggi la Munari nel mobile. Segno inconfondibile del talento e dello stile italiano.

Par affinité élective nous avons voulu consacrer la collection Munari à cette ville: MODENA, patrie des plus prestigieuses industries automobiles, sachant produire à la fois du design et de la technologie, comme le fait aujourd'hui Munari dans l'industrie du meuble. Signe reconnaissable du talent et du style italien.

Por una afinidad electiva hemos querido dedicar a esta ciudad la colección Munari: MODENA, como madre de las marcas de automóviles más prestigiosas, capaces de producir diseño y tecnología, al igual que hoy hace Munari con sus muebles.





LIGHTING UP  
YOUR  
HOME

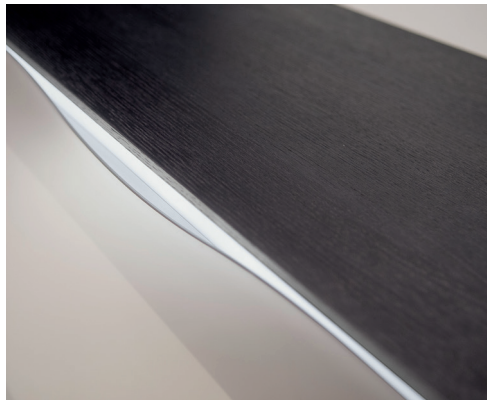

# COLLEZIONE MODENA



TV cabinet



Living



# CREATE YOUR HOME



Dining



Sideboard



Entrance

## MODENA DETAILS



MO 275 BI + TV support MI 310 / SP62



Sound System ACS 120 W



MO 150 BI + TV support AC 380 AN

CREATE  
YOUR  
STYLE!



# MODENA FINISHING & FEATURES

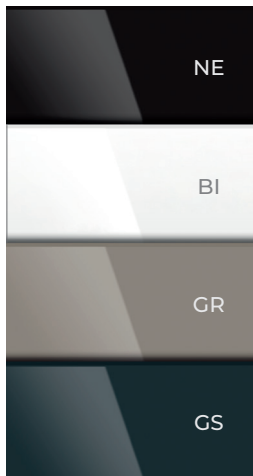

NE

Vetro nero lucido  
Verre noir brillant  
Vidrio negro brillante

BI

Vetro bianco lucido  
Verre blanc brillant  
Vidrio blanco brillante

GR

Vetro grigio lucido  
Verre gris brillant  
Vidrio gris brillante

GS

Vetro grigio scuro lucido  
Verre gris foncé brillant  
Vidrio gris oscuro brillante

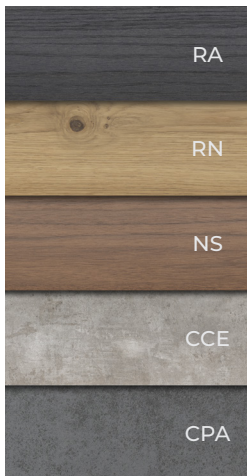

RA

Placcato rovere antracite  
Plaqué chêne anthracite  
Chapado en roble antracita

RN

Placcato rovere naturale  
Plaqué chêne naturel  
Chapado en roble natural

NS

Placcato noce scuro  
Plaqué noyer foncé  
Chapado en nogal oscuro

CCE

Ceramica effetto cemento  
Céramique effet béton  
Cerámica efecto hormigón

CPA

Ceramica effetto pietra antracite  
Céramique effet pierre anthracite  
Cerámica efecto piedra antracita



Tempered glass



Remote friendly glass door



LED lighting



Electric plant



Adjustable glass shelves



Safety brake



Cooling grills



Concealed castors

# PULL DOWN DOOR TV ELEMENTS

## MODENA GROUNDSTYLE

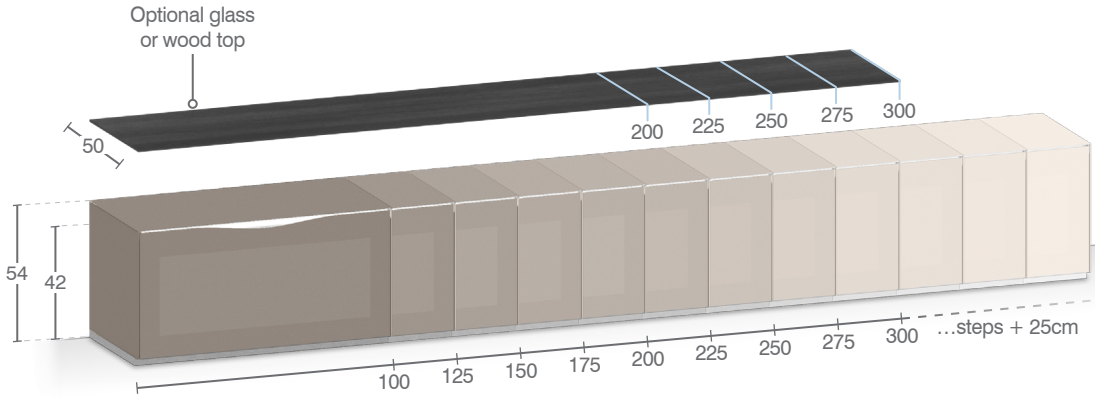

## MODENA WALLSTYLE

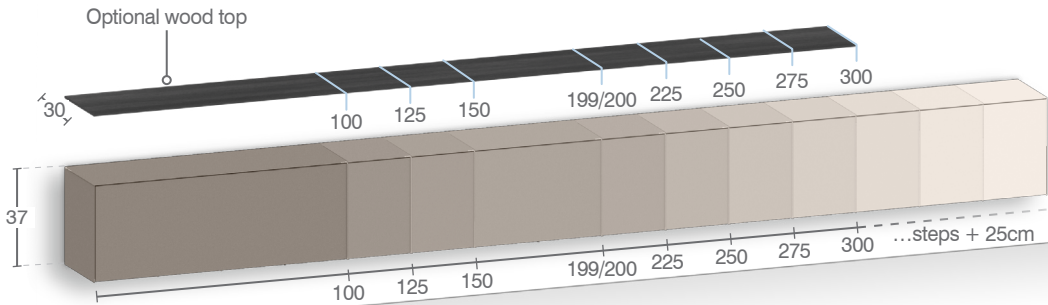

# GROUNDSTYLE



MO 106 BI + AC 200-100 RN

L. 100cm



MO 112 NE

L. 125cm

## MODENA TV CABINET



MO 150 GR + AC 200-150 RA + AC 131-150

L. 150cm



Home office VR 275 GS + MO 2200 GS + AC 200-200 RN

L. 75 + 200cm





MO 278 BI

L. 175cm



# DESIGN & SOUND



## SOUND SYSTEM ACS 120 W

L.95 H.18 P.30

Power: 120W RMS

Input: HDMI, Bluetooth,  
Coaxial, Aux TV, Optical  
Equalisation modes: live,  
rock, classic, simulate,  
disco, matrin

Power source:

110/220/240 Volt



Finitura carbonio  
Finition carbone  
Acabado en carbono



Doppio subwoofer  
Double subwoofer  
Subwoofer dual



Ingressi di collegamento  
Entrées de connexion  
Entradas de conexión



Display digitale  
Digital display  
Pantalla digital



# TV SUPPORT

MI 310 + SP 62

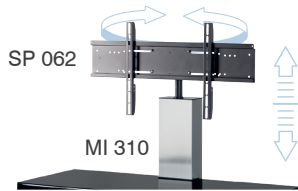

FI 096



AC 376

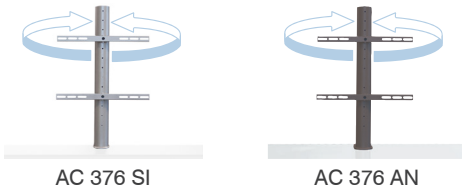

NEW

AC 380 AN

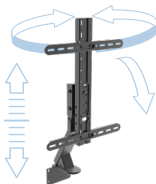

# MODENA LIVING GROUNDSTYLE





# MODENA LIVING WALLSTYLE







# MODENA LIVING FREESTYLE



MO 1223 BI

L. 220cm



VR 275 BI

L. 75cm

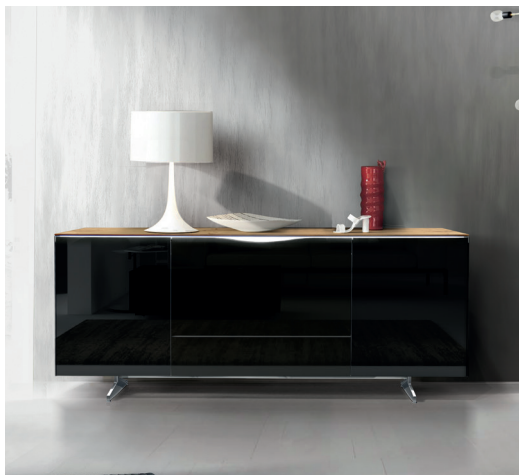

MO 1222 NE+AC 200-220 RN+AC 131-220 L. 220cm





MO 1120 GR-RA + AC 200-122 RA

L. 122cm



VR 1123 GS-RN

L. 122cm



VR 417 GR

L. 75cm



MO 114 GS

L. 120cm

# MODENA ENTREÉ

Design by Eros Angelini & Stephan König

Lo stile elegante di questa collezione rende la zona ingresso ordinata e organizzata, vetro e legno combinati assieme offrono molteplici colorazioni. I moduli sono indipendenti e possono essere collocati anche in altre aree della vostra casa.

Le style élégant de cette collection rend la zone d'entrée bien rangée et organisée, le verre et le bois combinés offrent de multiples couleurs. Les modules sont indépendants et peuvent également être placés dans d'autres zones de votre maison.

El estilo elegante de esta colección hace que el área de entrada sea ordenada y organizada, el vidrio y la madera combinados ofrecen múltiples coloraciones. Los módulos son independientes y también se pueden colocar en otras áreas de su vivienda.





HOME  
SWEET  
HOME



# MODENA ENTREÉ

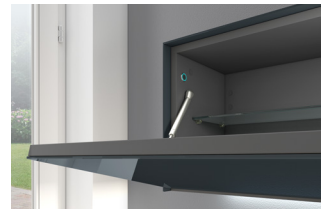

Pull-down soft-motion



Vasis soft-motion





# MODENA ENTREÉ



# WELCOME HOME



MOE 327 GR

MOE 327 NE-SP

MOE 321 GS

MOE 322 NE

MOE 325 / MOE 326





## DESIGN YOUR ENTRANCE



# COLLEZIONE MO&MA

---

Design by Eros Angelini

Nuova linea MO&MA: eleganza e funzionalità.  
Design e tecnologia si fondono armonicamente nella nuova  
linea Munari, come in un'opera d'arte moderna.  
L'unione tra design e materiali innovativi stabilisce standard  
di raffinatezza ancora più elevati.

Nouvelle ligne MO&MA: élégance et fonctionnalité.  
Design et technologie se marient harmonieusement dans  
la nouvelle ligne Munari, comme dans une oeuvre-d'art  
moderne. L'union entre design et matériaux novateurs  
établit un standard de raffinement encore plus élevé.

Nueva línea MO&MA: elegancia y funcionalidad.  
Diseño y tecnología se funden armónicamente en la nueva  
línea Munari, como una obra de arte moderno.  
La unión entre diseño y materiales innovadores establece  
un estándar de refinamiento aún mayor.





THE ART  
OF  
STYLE



# MO&MA DETAILS & FEATURES



MMB 174 R BI-BI-LNO

L. 175cm



Tempered glass



Remote friendly glass door



LED lighting

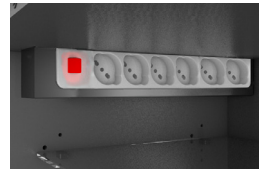

6 Way Multi plug included

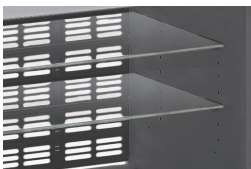

Adjustable glass shelves

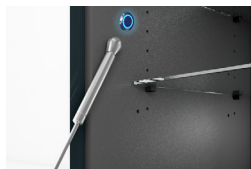

Safety brake



Cooling grills

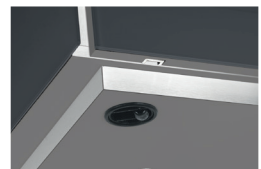

Concealed castors

# MO&MA FINISHING

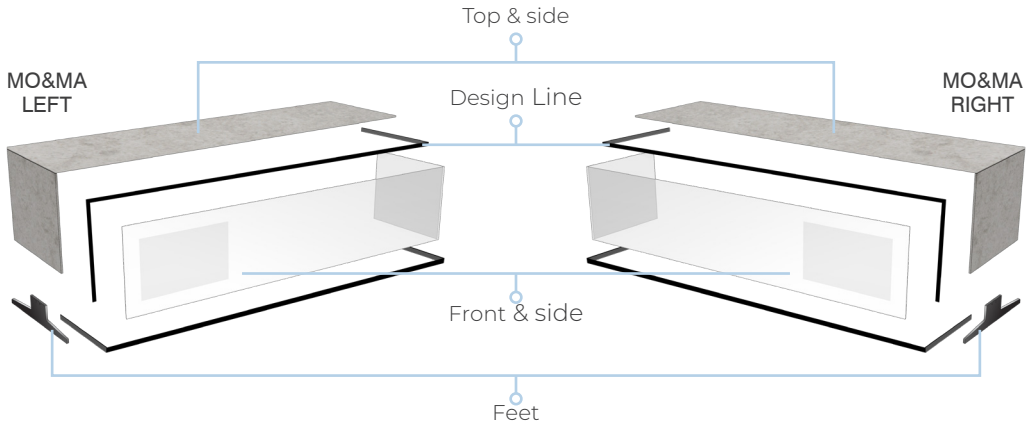

Front & side

Glass



Top & side

Glass



Wood



Ceramic



Design Line

LRS

LAS

LNO

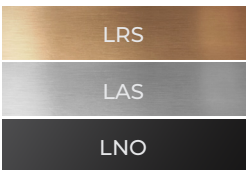

Feet

LRS

LAS

CR

LNO

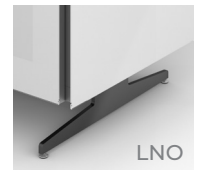
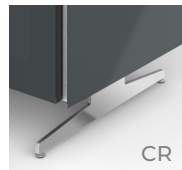
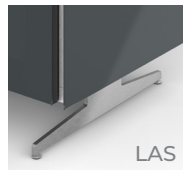



# PULL DOWN DOOR TV ELEMENTS

## MO&MA GROUNDSTYLE LEFT & RIGHT

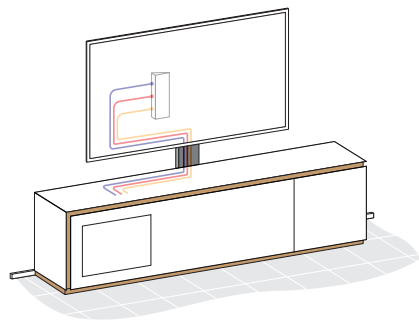
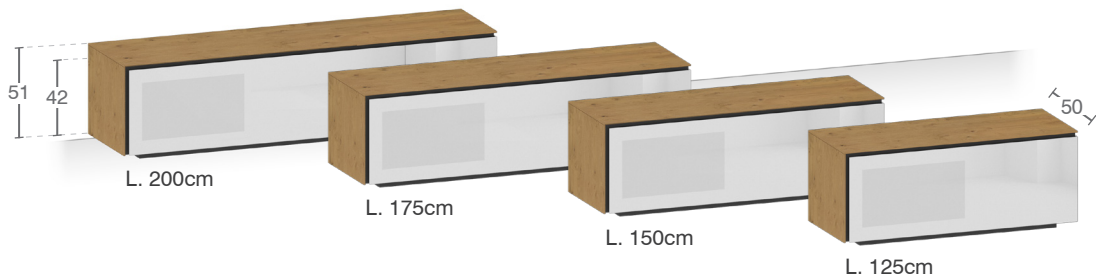

Mobile su ruote  
Meuble avec roulettes  
Mueble sobre ruedas

# PULL DOWN DOOR TV ELEMENTS

## MO&MA WALLSTYLE LEFT & RIGHT

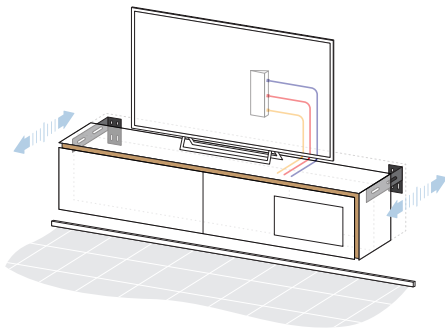
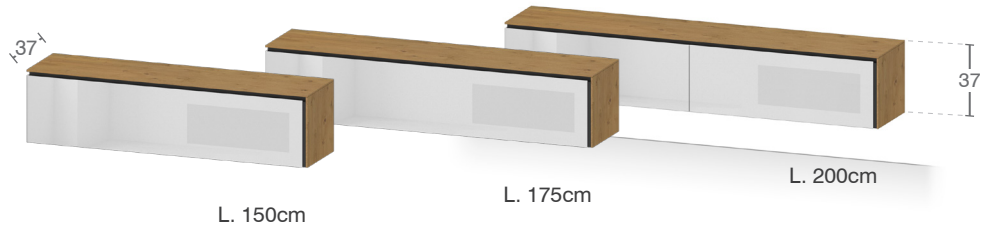

Mobile estraibile  
Meuble coulissant  
Mueble extraíble

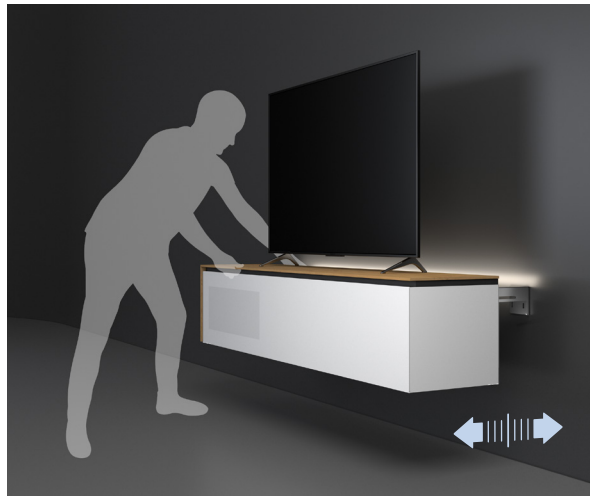

# MO&MA TV CABINET



MMB 202 L NE-NE-LRS

L. 200cm



MMB 150 R GS-GS-LAS

L. 150cm





MMB 202 L BI-RG-LNO + AC 131-200 LNO + Coffee table + Highboard

L. 200cm



SOUND SYSTEM ACS 120 W  
L.95 H.18 P.30



MMB 175 R BI-CCE-LAS

L. 175cm



# MO&MA TV CABINET



MMW 150 L BI-RA-LAS

L. 150cm



MMW 176 R GS-RN-LNO + Wall elements

L. 230cm



MMW 200 L NE-NE-LRS + Wall elements

L. 250cm

PERFECT  
FORM,  
CLEVER  
FUNCTION



MMW 200 R BI-CCE-LNO + Wall elements

L. 235cm



MMW 200 L GS-RG-LAS + Wall elements

L. 235cm

# MO&MA SIDEBORD LEFT & RIGHT



MMS 220 L GS-RN-LNO

L. 220cm



MMS 220 L NE-NE-LRS + AC 131-220 LRS L. 220cm



MMSW 200 R BI-RA-LAS

L. 200cm

# MO&MA COFFEE TABLE



MMT 120 BI-RG-LNO

L. 122cm



VR 081 BI

L. 81cm





# COLLEZIONE RAVENNA

---

Design by Eros Angelini

Il suo stile moderno e minimalista è stato studiato per poterla collocare in qualsiasi ambiente dal più giovane al più lussuoso.

Son style moderne et minimaliste a été conçu pour pouvoir être placé dans n'importe quel environnement, du plus jeune au plus luxueux.

Su estilo moderno y minimalista ha sido estudiado con el fin de poder ser colocado en cualquier lugar, desde el más moderno hasta el más lujoso.





ONE STYLE  
MANY  
SOLUTIONS



# RAVENNA DETAILS & FEATURES



RV 150 BIO BAS

L. 150cm



Tempered glass

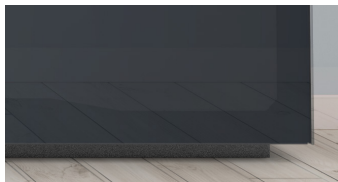

Remote friendly glass door



Metal handle

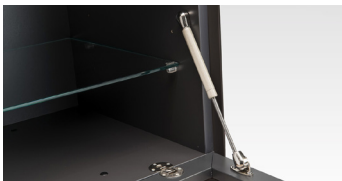

Safety brake



Adjustable glass shelves

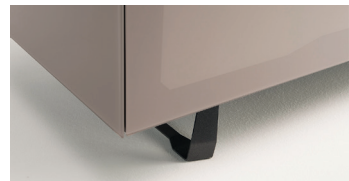

Feet or concealed castors

---

## GROUNDSTYLE



RV 126 BAS L.125 - H.49,5 - P.45



RV 150 BAS L.150 - H.37,5 - P.45



RV 152 BAS L.150 - H.49,5 - P.45



RV 176 BAS L.175 - H.49,5 - P.45

---

## FEETSTYLE

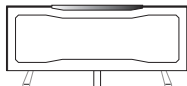

RV 126 F/P L.125 - H.58,5 - P.45



RV 150 F/P L.150 - H.46,5 - P.45



RV 152 F/P L.150 - H.58,5 - P.45

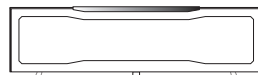

RV 176 F/P L.175 - H.58,5 - P.45



...NE nero / black / noir



...BI bianco / white / blanc

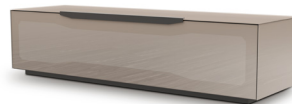

...GR grigio / grey / gris

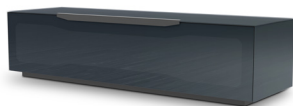

...GS grigio scuro / dark grey / gris foncé



...NEO nero opaco / matt black / noir mat

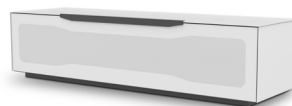

...BIO bianco opaco / matt white / blanc mat



## RAVENNA GROUNDSTYLE



RV 176 BIO BAS

L. 175cm



RV 152 NE BAS

L. 150cm

# RAVENNA FEETSTYLE



RV 176 GR F/P

L. 175cm



RV 150 GS F/P

L. 150cm



arreda l'elettronica

**MUNARI S.r.l.**

37050 Ca' degli Oppi di Oppeano (Verona) Italy

Ph. +39 045 7130145/190

[www.munari.it](http://www.munari.it)

e-mail: [munari@munari.it](mailto:munari@munari.it)

