

ITALIAN
AESTHETIC



ITALIAN
AESTHETIC
THE
TIC

INDEX

divani e poltrone
sofas and armchairs

Lily
12 - 21

Nova
22 - 37

2054
38 - 49

Modi Zero
50 - 57

sedute e tavoli
table and seats

Community set
58 - 71

Miss petra
72 - 77

Chips
78 - 87

Mr Lem
88 - 87

Bart
96 - 101

Pandora
102 - 109

Oxford
110 - 117

Liberty
118 - 125

banconi
counters

Nova bancone
126 - 137

Dublin
138 - 149

Baraonda
150 - 159

Display
160 - 165

coperture
cover

Kite
166 - 173

separatori
dividing wall

Nonvaso
174 - 181

Frames
182 - 191

Bagigio
192 - 199

lettini
sunbeds

Cloe
200 - 209

Zoe
210 - 217

Nova lettino
218 - 225

docce
showers

Dyno
226 - 231

vasi
pots

Pandora
232 - 239

Skin
240 - 247

Gem
248 - 257

Ampoule
258 - 265

Tao
266 - 271

accessori
accessories

Tino
272 - 279

Crazy head
280 - 285

Tech index
138 - 189

Designers
194 - 197

My your è passione per il design, per la ricerca, fra linea e tecnologia, per competere nel mercato worldwide, sempre più esigente e in continua espansione.

Una vita nel colore, nella forma positiva, giocosa ed eccellente della materia plastica. Un team dinamico, preparato ed efficace per rispondere ad ogni richiesta del Cliente.

Un'azienda giovane, in cui l'interazione fra tecnologia ed esperienza trentennale nel settore delle materie plastiche, risulta essere la vera forza della libertà creativa, della diffusione e dell'eccellenza nel processo produttivo.

My your è, dopo dieci anni dalla sua fondazione, un'azienda consolidata, una coesione fra saper fare e un'identità in costante mutamento, sempre pronta ad accogliere nuovi trend, nuove esperienze creative per ogni esigenza, indoor e outdoor, dell'abitare.

My your is passion for design, research, between line and technology, to compete in a global market, increasingly demanding and ever expanding.

A life in color, in the positive, playful and excellent form of plastic material. A dynamic team, prepared and efficient to respond to every need of the Customer.

A young company, in which the interaction between technology and decades of experience in the plastics sector, appears to be the real strength of creative freedom, the spread and excellence in the industrial production.

My your is, after ten years since its foundation, established company, a cohesion between know-how and identity constantly changing, always ready to welcome new trends, new creative experiences for every need, indoor and outdoor living.



MY
YOUR
IS

ITALIAN AESTHETIC THE TIC

L'esperienza visiva dei prodotti **Myyour** è estremamente importante. Questa include l'illuminazione, l'arredamento per la casa e per il settore contract, e i complementi, come tappeti e cuscini, che aiutano sempre a creare un ambiente accogliente.

La tendenza si concretizza nell'utilizzo della materia plastica attraverso nuove tecniche di lavorazione, che ne trasformano la superficie in infinite possibilità in grado di soddisfare sia la vista che il tatto.

Esprimere un'estetica che renda felici le persone, congiuntamente alla capacità tecnica, che garantisce sicurezza e qualità nei prodotti, è il fondamento su cui, ogni giorno, tutto il team **Myyour** lavora.

The visual experience of **Myyour's** products is extremely important. This includes lighting, furnishings, for the home and for the contract sector, and accessories as rugs and pillows, which always help to create a welcoming environment.

The trend is realized in the use of plastic material through new processing techniques, which transform the surface into endless possibilities able to satisfy both the eye and the touch.

Express an aesthetic that makes people happy, together with the technical ability, which guarantees safety and quality of products, it's the foundation with which, every day, all the **Myyour** team works.



LILY

Lily è una collezione forte e poetica, disegnata da MoreDesign. Il cuore del progetto Lily è il concetto del petalo di fiore, la cui forma fluente sfida le tecniche di ingegnerizzazione.

Un'interpretazione fresca e nuova del concetto living e dining, ovunque voi siate.

Lily is a strong and poetic collection designed by MoreDesign. The heart of Lily's project is the flower petal concept, whose organic shape challenges engineering techniques.

A fresh and new interpretation of the concept of living and dining, wherever you are.

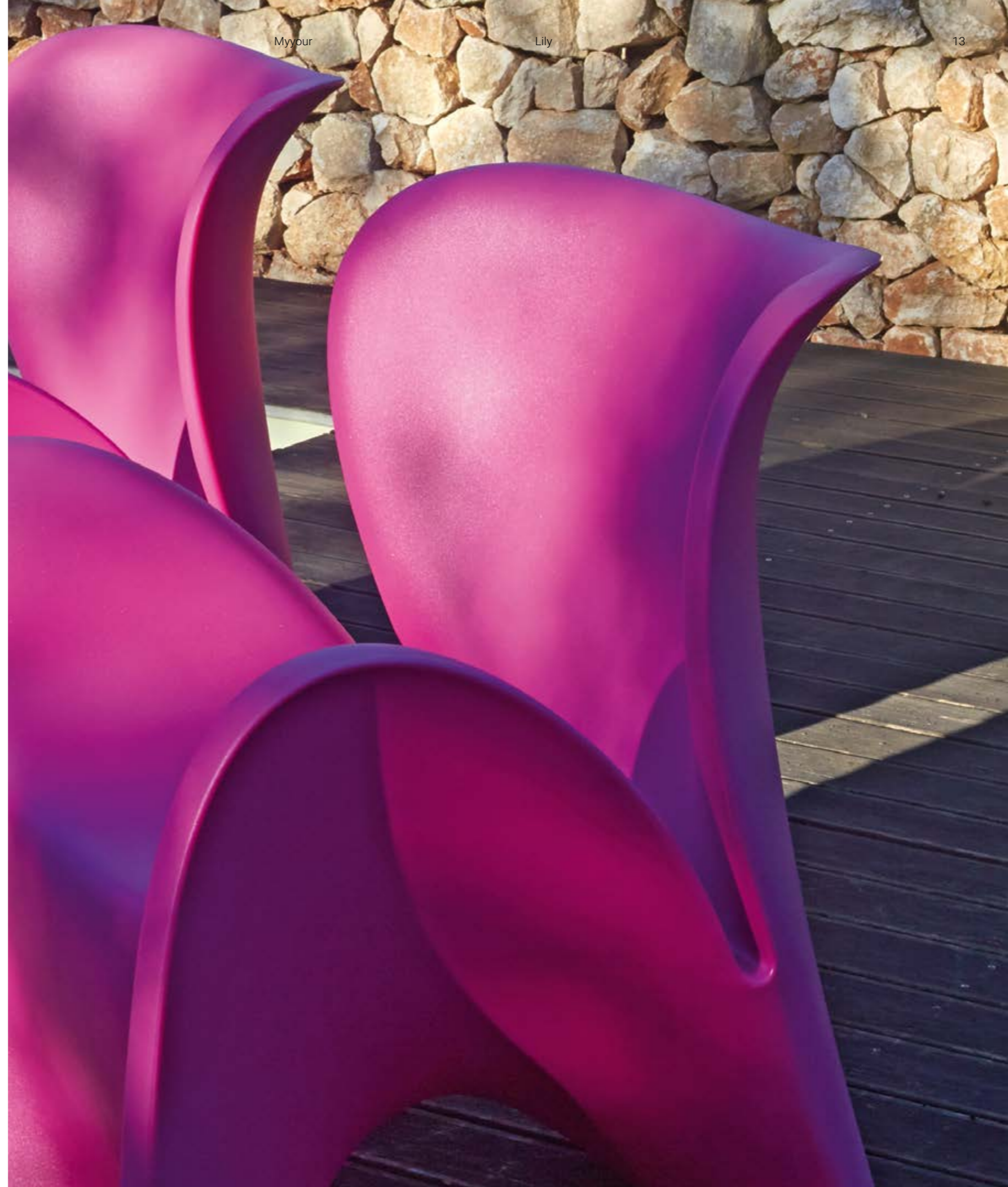



Divano Lily
Lily sofa

Tavolo Lily RGB/W
Lily RGB/W table

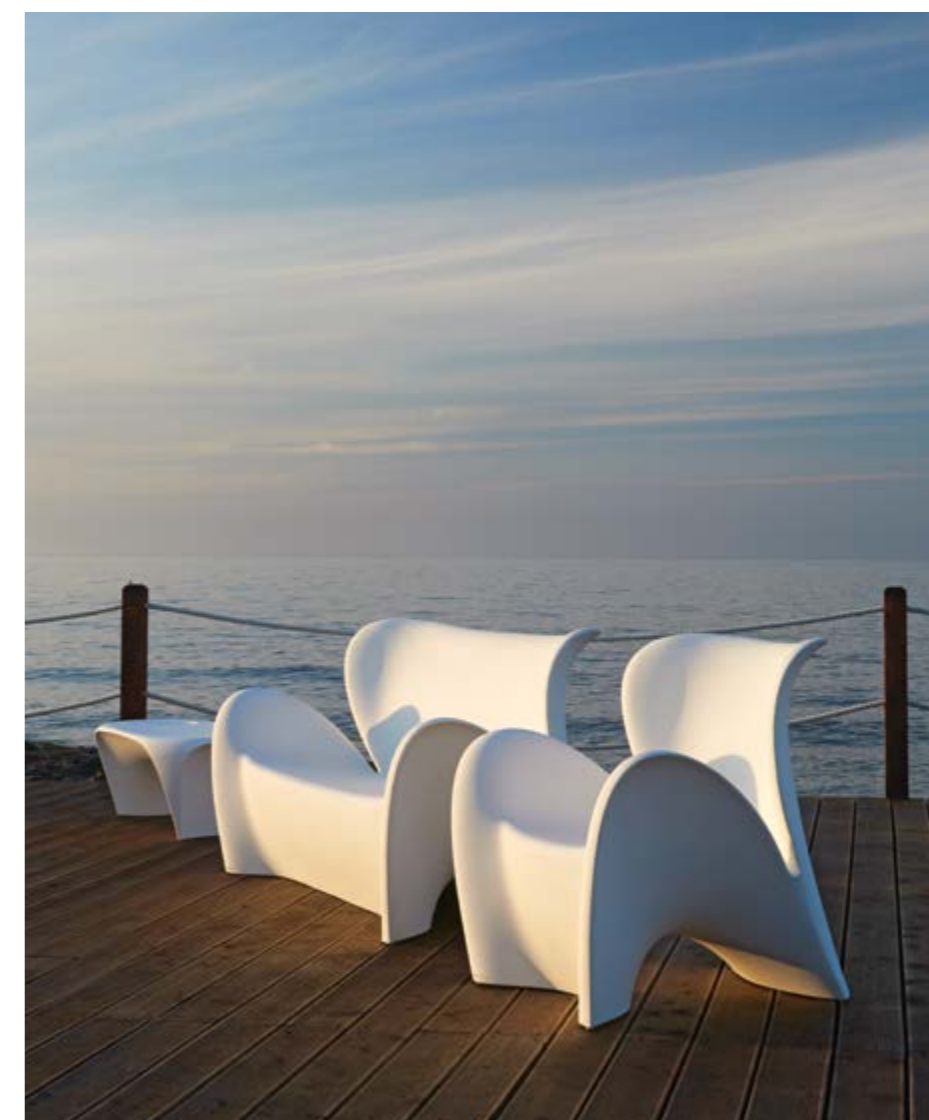

Poltrone e tavolo Lily
Lily armchairs and table

Divano, poltrone e tavolo con spumantiera Lily
Lily sofa, armchairs and table with ice box

Misure H91 x L63 x W69 cm
Measures

Finiture GS LV
Finishing

Lily sedia
Lily chair



Misure H91 x L85 x W81 cm
Measures

Finiture GS LV
Finishing

Lily poltrona
Lily armchair



Misure H91 x L179 x W86 cm
Measures

Finiture GS LV
Finishing

Lily divano
Lily sofa





Misure H79 x L69,5 x W93 cm
Measures

Finiture GS LV IL
Finishing

Luce 1xRGBW induction rechargeable
Light

No luce
No light

Misure H75 x L10 x W93 cm
Measures

Finiture PC
Finishing

Lily tavolo
Table lily

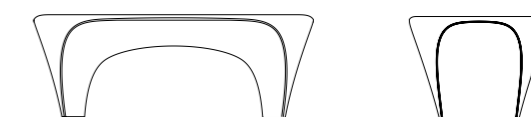

Lily spumantiera
Lily spumante



NOVA

Una raffinata semplicità contraddistingue il divano S e la poltrona Nova; il loro design pulito e neutro, caratterizzato da linee essenziali ed eleganti, li rende oggetti inseribili in qualsiasi contesto stilistico.

A refined simplicity distinguishes the Nova sofa S and Nova armchair; their clean and neutral design, characterized by essential and elegant lines, makes them objects that can be inserted into any stylistic context.



Divano, poltrone e divano S Nova imbottiti
Nova sofa, armchair and sofa S padded

Tavolo 2054
2054 table





Divano e poltrone imbottite Nova S, tavolo 2054
Nova S padded sofa and armchairs, 2054 table

Nova S poltrona imbottita
Nova S padded armchair

Misure H75 x L75 x W76 cm
Measures

Misure seduta H45 cm
Seat measures

Finiture GS IL OV
Finishing

Imbottitura DryFeel
Padding

Rivestimento TE
Upholstery

Luce 1x E27, 1x RGBW cable rechargeable
Light

No luce
No light

Nova poltrona imbottita
Nova padded armchair

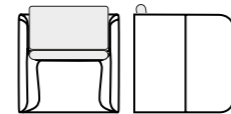

Misure H75 x L150 x W76 cm (Nova divano S imbottito)
Measures (Nova S padded sofa)

Misure H140 x L175 x W93,5 cm (Nova divano imbottito)
Measures (Nova padded sofa)

Finiture GS IL OV
Finishing

Imbottitura DryFeel
Padding

Rivestimento TE
Upholstery

Luce 2x E27, 1x RGBW cable rechargeable
Light

No luce
No light

Nova divano S imbottito
Nova S padded sofa

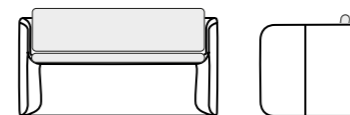

Nova divano imbottito
Nova padded sofa

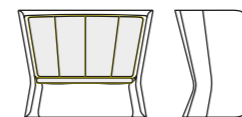

Misure H75 x L75 x W76 cm
Measures

Finiture GS IL OV
Finishing

Luce 1x E27, 1x RGBW cable rechargeable
Light

No luce
No light

Nova 2054 tavolo
Nova 2054 table





Misure H75 x L75 x W76 cm
Measures

Misure seduta H45 cm
Seat measures

Finiture GS IL OV
Finishing

Luce 1x E27, 1x RGBW cable rechargeable
Light

No luce
No light

Nova poltrona
Nova armchair

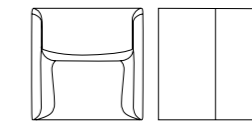

Misure H140 x L175 x W93,5 cm (Nova divano imbottito)
Measures (Nova upholstered sofa)

Misure H75 x L150 x W76 cm (Nova divano S imbottito)
Measures (Nova S upholstered sofa)

Finiture GS IL OV
Finishing

Luce 2x E27, 1x RGBW cable rechargeable
Light

No luce
No light

Nova divano S
Nova S sofa

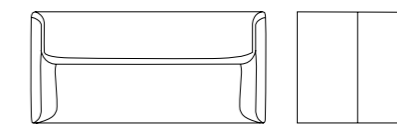

Nova divano
Nova divano



Misure H75 x L75 x W76 cm
Measures

Finiture GS IL OV
Finishing

Luce 1x E27, 1x RGBW cable rechargeable
Light

No luce
No light

Nova 2054 tavolo
Nova 2054 table

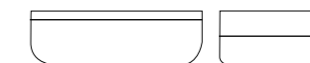

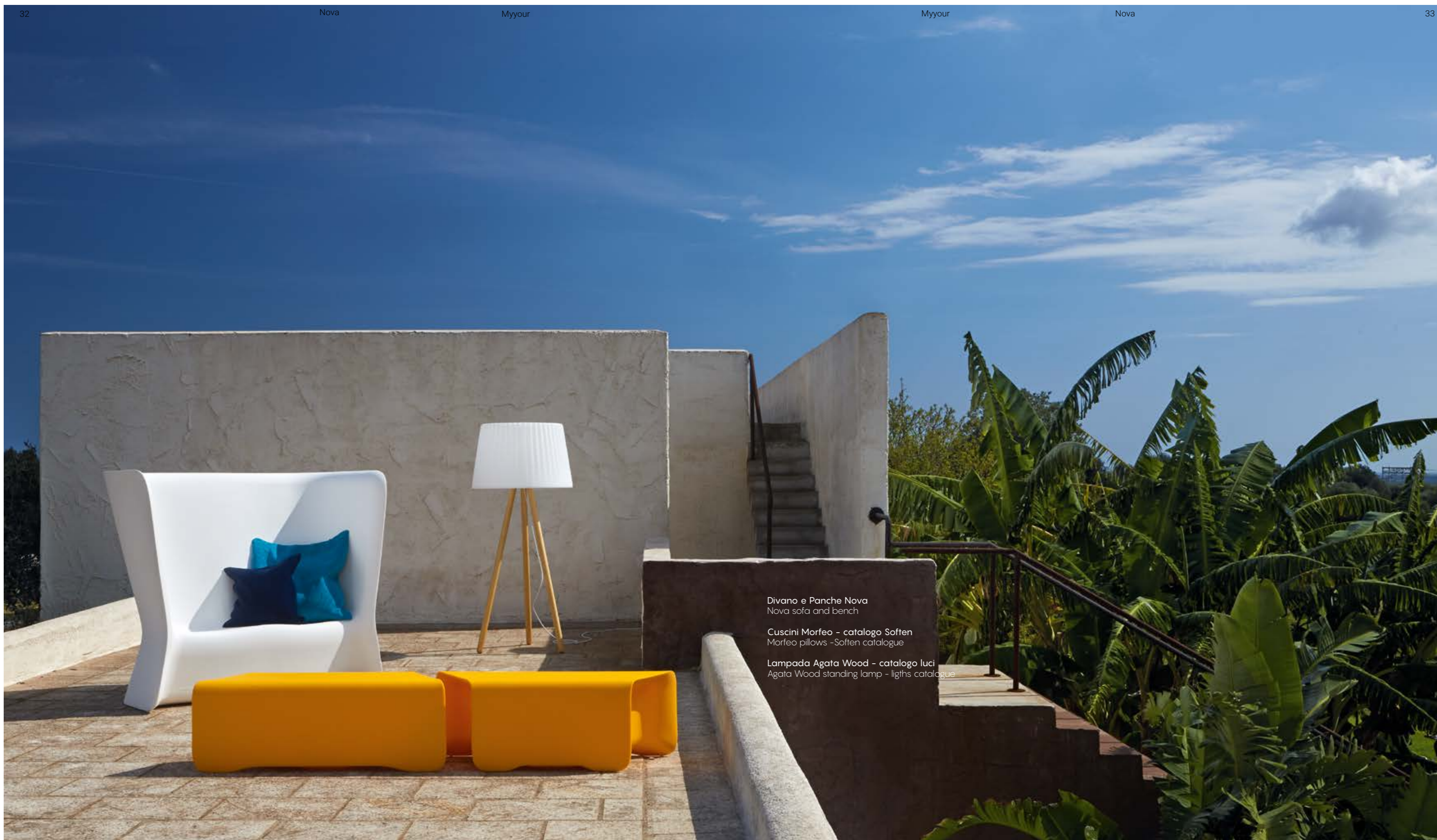

Divano e Panche Nova
Nova sofa and bench

Cuscini Morfeo - catalogo Soften
Morfeo pillows - Soften catalogue

Lampada Agata Wood - catalogo luci
Agata Wood standing lamp - lights catalogue



Panca Nova
Nova bench



Misure H42 x L117 x W38cm
Measures

Finiture GS LV IL OS
Finishing

Luce 1x E27, 1x RGBW cable rechargeable
Ligth

No luce
No lighth

Nova panca
Nova bench



2054

2054 imbottito segue lo stesso linguaggio del monoblocco fatto di superfici planari e raccordi circolari con in più il comfort della seduta in dryfeel che ne permette l'utilizzo all'esterno.

2054 è un sistema modulare di sedute interamente in Poleasy pensate tanto per l'indoor quanto per l'outdoor.

2054 interpreta un design minimal e futuristico e introduce un concetto molto versatile di modularità. Un semplice aggancio permette di avere una poltrona singola o un divano componibile di lunghezza variabile con la possibilità di scegliere tra versione illuminata o senza luce.

Upholstered version of 2054 follows the same language of the monoblock made of planar surfaces and circular fittings but with the added comfort of dryfeel sitting that allows it to be used outdoors.

2054 is a modular system entirely in Poleasy thought for both indoor and outdoor.

2054 translate a minimal and futuristic design and introduce a versatile concept of modularity. A simple hang permit to have a single armchair or a composable sofa of variable lengths with the possibility to choose between illuminable version or without light.



Divano e poltrone 2054 imbottito, bracciolo slim
Padded sofa and armchairs 2054, slim arm

Tavolo 2054 pag. 44
2054 table page 44

Tappeto Teo - catalogo Soften
Teo rug - Soften catalogue



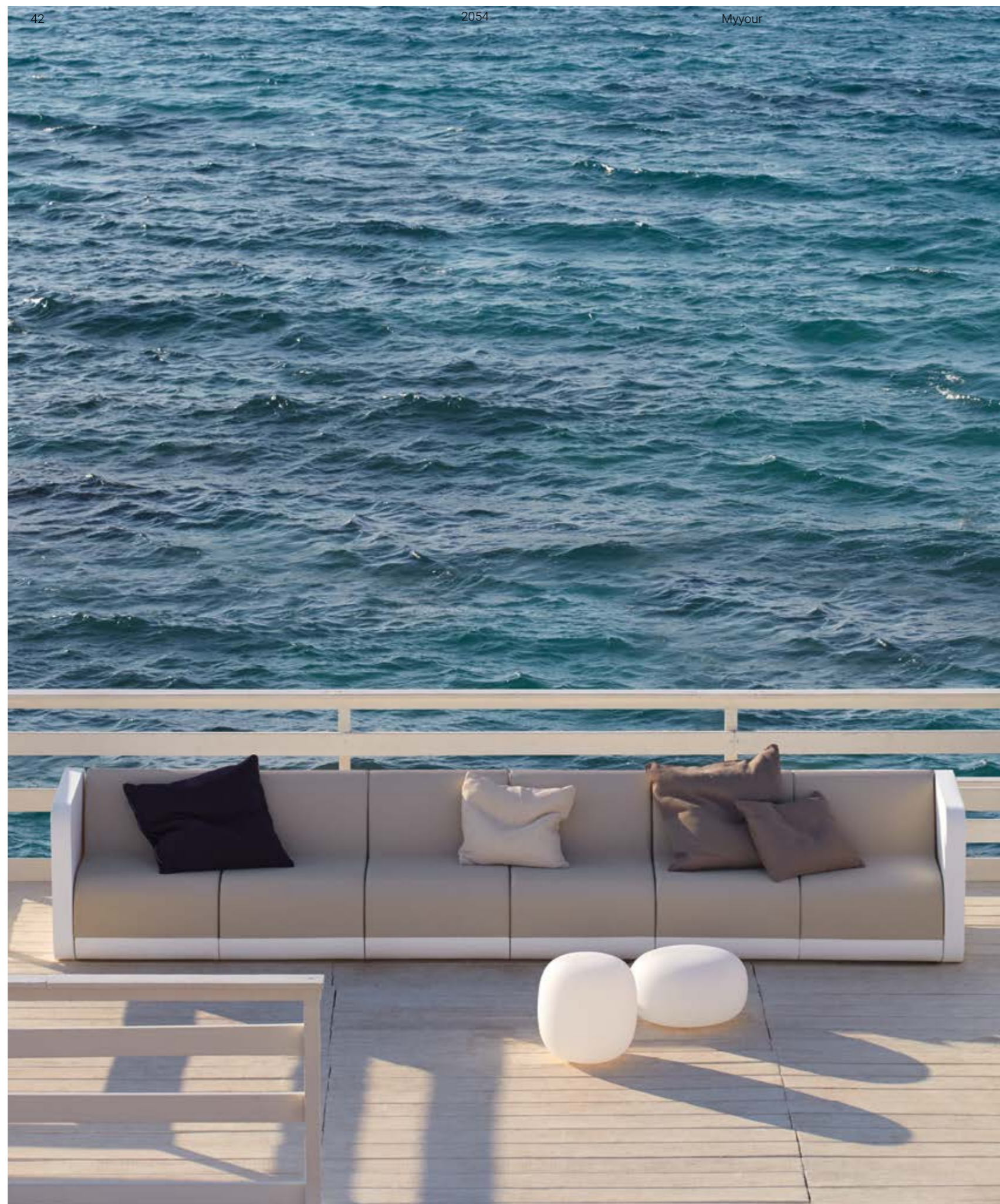

Divano 2054 imbottito, cuscini Morfeo e Pandora pouf S e M
2054 padded sofa Morfeo pillows and Pandora pouf S and M

Tavolo e Divano imbottito senza braccioli 2054
2054 table and sofa padded without arms

Misure H75 x L69,5 x W93 cm
Measures

Altezza seduta H38 cm
Seat height

Finiture GS LV
Finishing

Imbottitura DryFeel
Padding

Rivestimento TE
Upholstery

2054 imbottito
2054

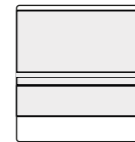

Misure H75 x L76,5 x W93 cm
Measures

Altezza seduta H38 cm
Seat height

Finiture GS LV
Finishing

Imbottitura DryFeel
Padding

Rivestimento TE
Upholstery

2054 imbottito e un bracciolo
2054 padded and one armrest

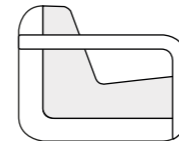
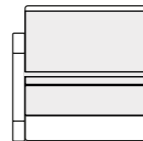

Misure H75 x L83,5 x W93 cm
Measures

Altezza seduta H38 cm
Seat height

Finiture GS LV
Finishing

Imbottitura DryFeel
Padding

Rivestimento TE
Upholstery

2054 poltrona imbottita
2054 padded armchair

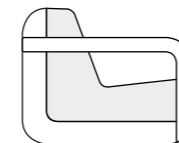
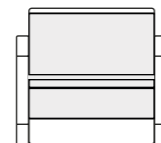

Misure H30 x L93 x W60 cm
Measures

Finiture GS LV OV
Finishing

Luce 1x RGBW cable rechargeable
Ligth

No luce
No lighth

2054 tavolo
2054 table

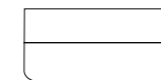
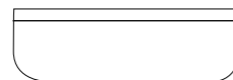



Divano 2054 monoblocco con bracciolo slim
2054 monobloc sofa with slim arm

Divano monoblocco, poltrona monoblocco e tavolo 2054, tavoli pandora e cuscino Morfeo
2054 Monobloc sofa, armchair and table, pandora tables and Morfeo cushions

Misure H75 x L69,5 x W93 cm
Measures

Altezza seduta H36 cm
Seat height

Finiture GS LV IL
Finishing

Luce 1xE27, 1xRGBW cable rechargeable
Light

No luce
No light

2054 monoblocco
2054 monobloc seat

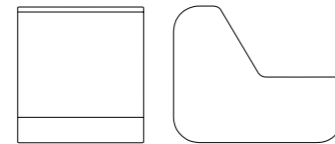

Misure H75 x L79,5 x W93 cm
Measures

Misure H75 x L89,5 x W93 cm
Measures

Altezza seduta H36 cm
Seat height

Finiture GS LV
Finishing

Luce 1xE27, 1xRGBW cable rechargeable
Light

No luce
No light

2054 bracciolo slim
2054 slim armrest

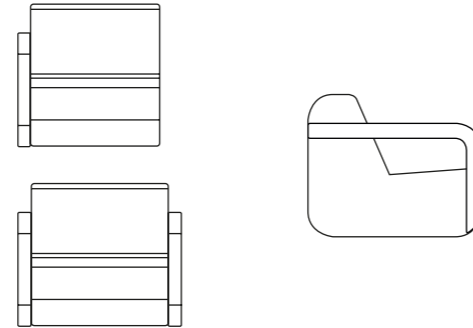

Misure H75 x L58 x W93 cm
Measures

Misure H75 x L83,5 x W93 cm
Measures

Finiture GS LV OV OS
Finishing

Altezza seduta H36 cm
Seat height

Luce 1xE27, 1xRGBW cable rechargeable
Light

No luce
No light

2054 bracciolo slim
2054 slim arm

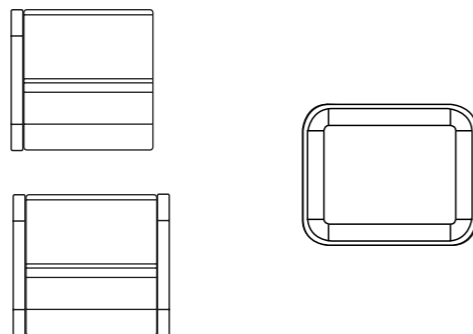

2054 tavolo vedi pag. 44
2054 table see page.44



MODI '0 ZERO

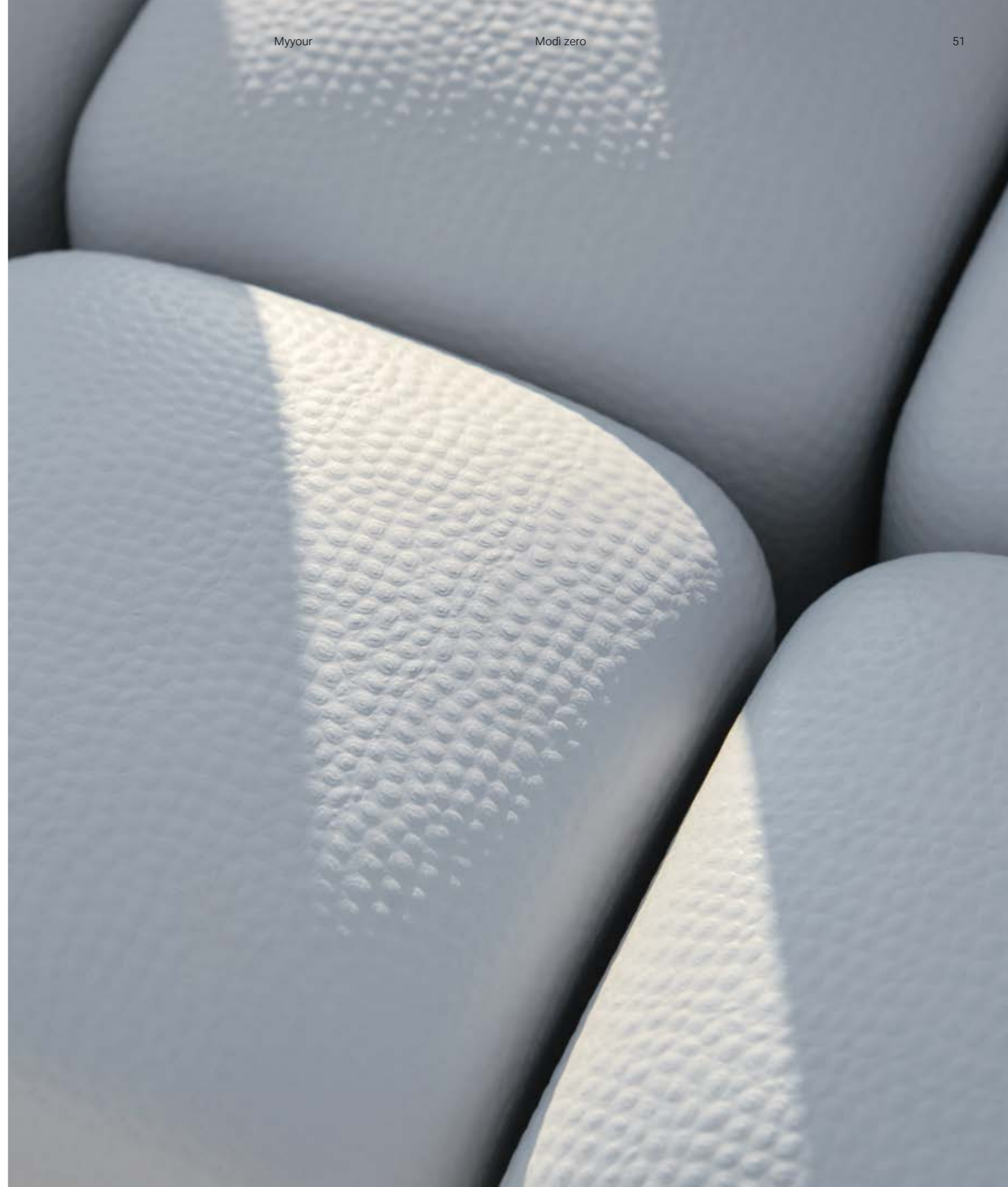

Modi Zero divani e tavoli
Modi Zero sofas and tables

Lampade Hollywood - catalogo luci
Hollywood standing lamps - lights catalogue





Sedute e tavoli Modi Zero.
Modi Zero seats and tables



Misure H35 x L83 x W62 cm
Measures

Finiture VT
Finishing

Misure H44 x L83 x W62 cm
Measures

Finiture GS LV OS
Finishing

Elementi seduta EVA
Seats elements

Misure H70 x L83 x W72 cm
Measures

Finiture GS LV OS
Finishing

Elementi seduta EVA
Seats elements

Misure H70 x L186 x W72 cm
Measures

Finiture GS LV OS
Finishing

Elementi seduta EVA
Seats elements

Modi tavolo
Modi table

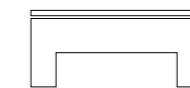

Modi pouf
Modi pouf

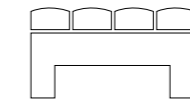

Modi seduta
Modi seats

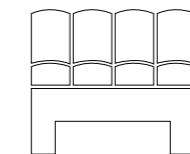

Modi divano
Modi sofa

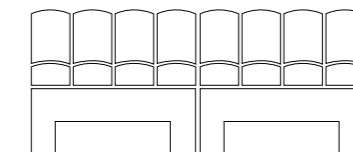

COMMUNITY SET

Tavoli e sedie si fondono in un'unica forma, così Community diventa metafora dell'aggregazione che stimola grazie ad atmosfere informali e amichevoli.

Grazie ai tavoli con piano in Corian, HPL o vetro satinato temperato il sistema Community offre 4, 6, 8 oppure 10 posti e permettono l'allestimento di qualsiasi spazio pubblico o privato.

Tables and chairs merge into a single form. So Community becomes a metaphor of the aggregation that stimulates, in an informal and friendly atmosphere.

Thanks to the table with Corian, HPL or satin glass top, the Community system offers 4, 6, 8 or 10 places and allows the outfitting of any public and private space.





Poltroncina Rhonda e tavolo Teddy
Rhonda chair and Teddy table

Tulip XL - catalogo luci
Tulip XL - lights catalogue



Tavolo Joe, 6 sedie Rhonda e Lucy in versione Community 6
Community 6 with Joe table, 6 Rhonda and Lucy armchairs

Poltroncine Lucy
Lucy armchairs

Poltroncine Rhonda
Rhonda armchairs





Tavolo Joe, 8 sedie Rhonda e Lucy in versione Community 8
Community 8 with Joe table, 8 Rhonda and Lucy armchairs

Poltroncine Lucy
Lucy armchairs

Poltroncine Rhonda
Rhonda armchairs



Tavolo Joe, 10 sedie Rhonda e Lucy in versione Community 10
Community 10 with Joe table, 10 Rhonda and Lucy armchairs

Poltroncine Lucy
Lucy armchairs

Poltroncine Rhonda
Rhonda armchairs







Misure H72 x L119 x W119 cm
Measures

Finiture GS IL
Finishing

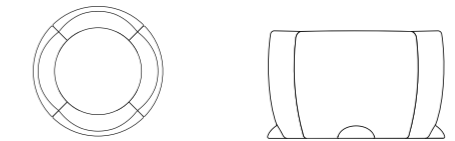
Community 4
Community 4



Misure H73 x L174 x W128 cm
Measures

Finiture GS HPL VT IX 
Finishing

Community 6
Community 6

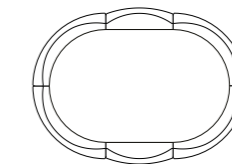

Misure H73 x L229 x W128 cm
Measures

Finiture GS HPL VT IX 
Finishing

Community 8
Community 8

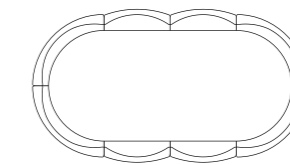

Misure H73 x L284 x W128 cm
Measures

Finiture GS HPL VT IX 
Finishing

Community 10
Community 10

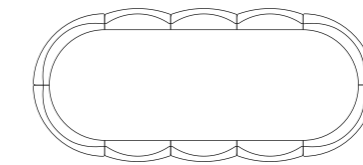

Misure H73 x Ø 90 cm
Measures

Misure H73 x L 147 x W 92 cm
Measures

Finiture HPL VT IX Corian
Finishing

Joe 4
Joe

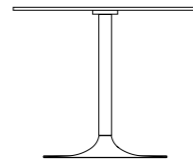

Joe 6
Joe

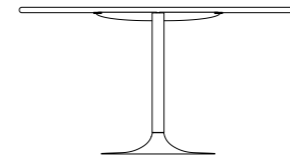

Misure H73 x L 202 x W 92 cm
Measures

Misure H73 x L 257 x W 92 cm
Measures

Finiture HPL VT IX Corian
Finishing

Joe 8 - Joe 10
Joe

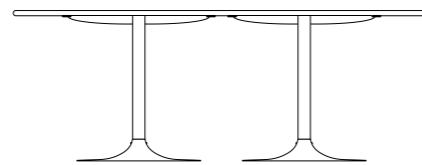

Misure H72 x L55 x W55 cm
Measures

Finiture GS
Finishing

Lucy
Lucy

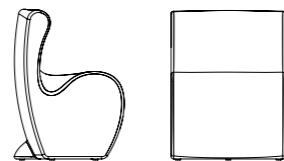

Misure H72 x L83 x W51 cm
Measures

Finiture GS
Finishing

Rhonda
Rhonda

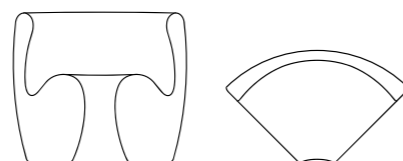

MISS PETRA

Con le sue curve morbide ed estreme, Miss Petra sfida la gravità con una resistenza insuperabile.

Questa forma esile e senza spigoli nasconde una struttura potente.

Un vero gioiello di design con forme sinuose, avvolgenti e confortevoli.

The extremely soft curves of Miss Petra defy gravity with an overwhelming resistance.

This slender form, which does not have any edges, hides a powerful structure.

A real gemstone of design with curvy, enveloping and comfortable forms.





Poltroncina Miss Petra
Miss Petra armchair

Miss petra

Myyour



Myyour

Miss petra

Misure H81 x L74 x W60 cm
Measures
Finiture GS EC
Finishing

Miss Petra
Miss Petra

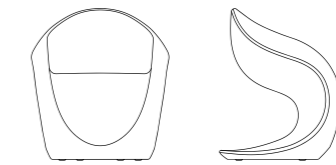

CHIPS

Lo svuotamento della materia, la riduzione sintetica della struttura lungo le linee tensionali, "nervose", organiche della scocca in polietilene, genera una sedia eterea, realizzata sia con gambe che con slitta.

Lo sgabello Chips completa questa serie di sedute con due altezze abbinabili rispettivamente all'ambiente domestico e ai locali pubblici. Un etereo quadrifoglio ritagliato dal piano in HPL e sospeso su steli metallici che lo fanno librare leggero. Un tavolo impilabile, anticonvenzionale, capace di convivere con la storia, di interpretare il presente, di sognare un futuro.

Leggerezza e praticità sono le caratteristiche vincenti che caratterizzano anche la panca. Realizzata in polietilene con scelta fra numerosi colori lucidi stampati, la panca Chips dispone di telaio a tubo unico verniciato con processo unico di cataforesi antiruggine ad immersione che caratterizza tutta la serie.

The emptying of matter, the synthetic reduction of the structure along the "nervous", stress lines, the organics of the polyethylene body, generate an ethereal chair, realized with legs or slide.

The Chips stool complete this serie of seats with two heights matching respectively to the domestic and public places.

An ethereal four-leaf lover cut out of the HPL top and suspended on metal stems that make it lightly glide. A stackable, unconventional table, capable of living in harmony with history, of interpreting the present and dreaming the future.

Lightweight and convenience represent the winning characteristics of the bench too. Realized in polyethylene with a wide choice of smooth finished colors, Chips bench has a structure that is made with a single coated tube, which has undergone an anti-rust process such as the electroplating process by dipping, distinguishing the entire collection.





Sedie Chips versione con gambe
 Chips chairs with legs version



Misure H73 x L78 x W78 cm

Measures

Finiture HPL ML

Finishing

Tavolo Chips
Chips table

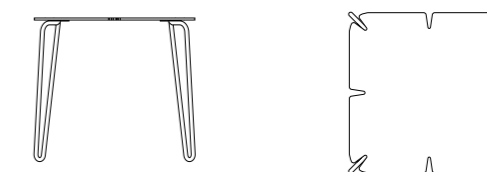

Misure H79 x L56 x W60 cm

Measures

Finiture GS ML

Finishing

Chips sedia versione con gambe
Chips chair legs version



Misure H79 x L56 x W60 cm

Measures

Finiture GS ML

Finishing

Chips sedia versione con slitta
Chips chair slide version

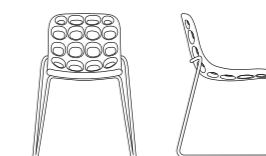

Misure H81 x L46 x W50 cm
Measures

Finiture GS ML
Finishing

Chips Sgabello h74
Chips h74 stool

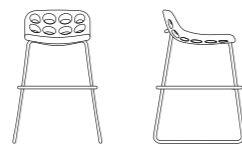

Misure H90 x L48 x W52 cm
Measures

Finiture GS ML
Finishing

Chips Sgabello h85
Chips h85 stool

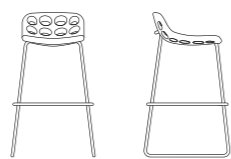



Misure H50 x L82x W40 cm
 Measures
Finiture GS ML
 Finishing

Chips panca
 Chips bench

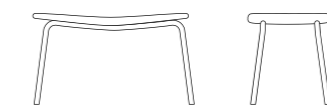

MR LEM

Abbiamo cercato di coniugare in&outdoor uscendo dalle forme classiche traendo come forma di ispirazione una "navicella spaziale" e il primo sbarco sulla luna.

Linee decise, figura semplice, senza perdere di vista gli aspetti pratici del trasporto e dell'archiviazione, che permettono di sistemare due pouf nell'ingombro di uno, grazie alla sua simmetria. Se capovolto, Mr Lem diventa base di un simpatico tavolino con piano in vetro o HPL.

We have tried to join in&outdoor by abandoning the classic shapes using a "space ship" and the first landing on the Moon as inspiration.

Decisive lines and simple shape, without losing sight of the more practical aspects tied to transport and placement, which enable putting two poufs in the space of one, thanks to symmetry.

If turned upside down, Mr Lem become a funny base a table with glass or HPL top.





Sgabelli Mr. Lem
Mr. Lem stools



Tavolo Mr Lem con piano in vetro
Mr Lem table with glass top

Misure H45 x L50,4 x W51 cm
Measures

Finiture GS LV
Finishing

Misure diametro 70 cm
Measures

Finiture VT HPL
Finishing

Mr Lem sgabello / fusto per tavolo
Mr Lem stool / table base

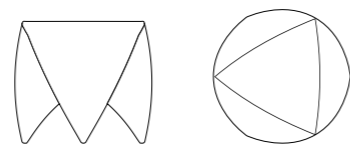

Mr Lem top
Mr Lem top

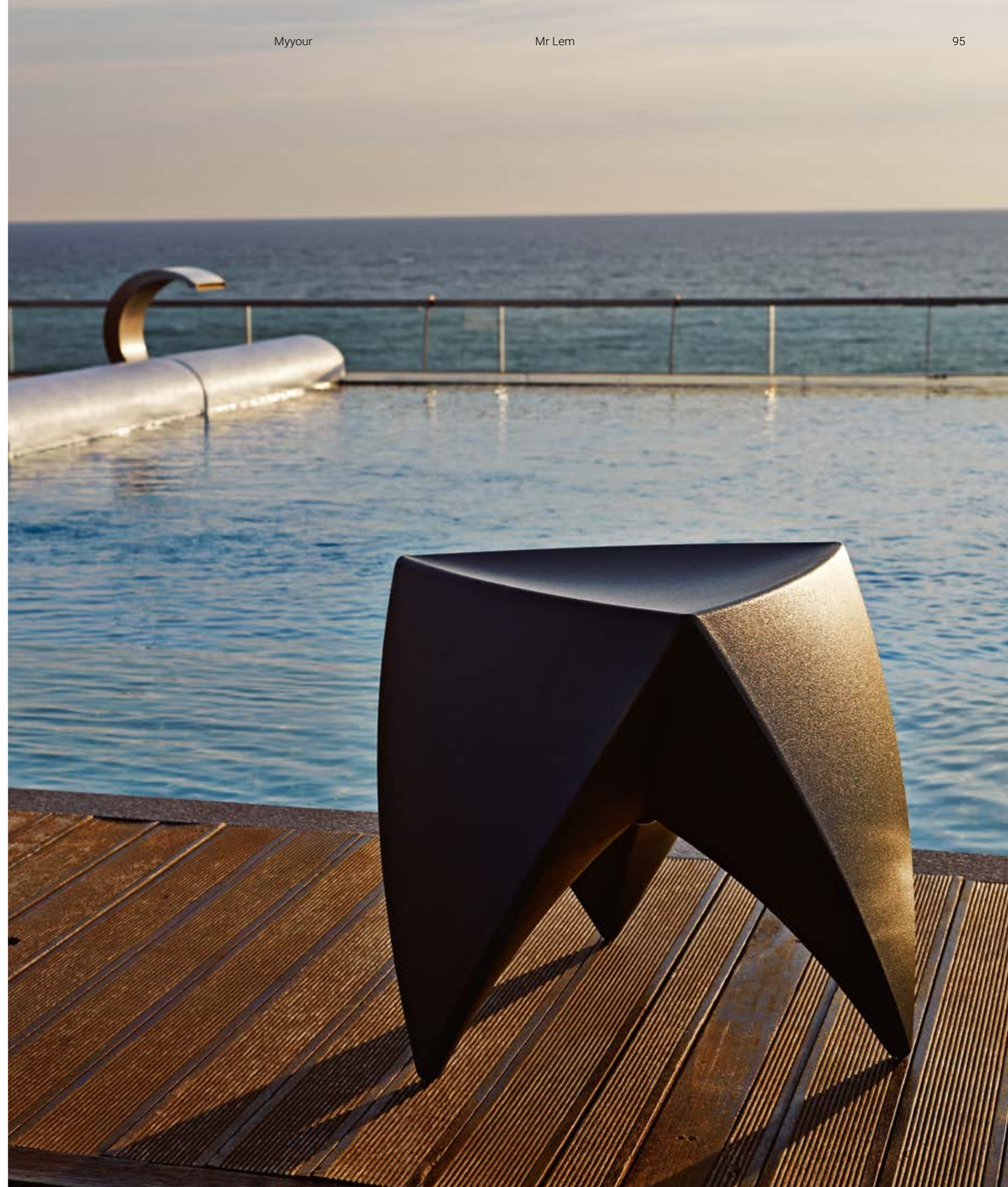
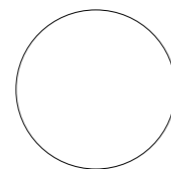

BART

Simbolo di moda e tendenza, Bart si presta a differenti soluzioni d'arredo. E' sgabello, ma anche tavolo che caratterizza inconfondibilmente un ambiente, con la sovrapposizione di un piano di vetro trasparente o in HPL. E' sempre lui: Jolly Roger. Qui però si presenta con stile, con accenti festaioli ma sempre in tono decisamente cool. Accetta così di cambiare abito, colore, di farsi sgabello, tavolo.

Fashion and trend symbol, Bart lends itself to various design solutions. It is a stool, but it is also a table that characterized uniquely the environment, with the superposition of a top of transparent glass or HPL. It's always him: Jolly Roger. Here it comes with style, with party-loving accents but always in a very cool tone. It accepts to change clothing, colour, to become a stool, a table.





Sgabelli Bart
Bart stools



Misure H45 x L32 x W32 cm
Measures

Finiture GS IL OV
Finishing

**Luce 1x E27 32W light bulb,
Rgw 3,8w Induction Rechargeable**
Light

No luce
No light

Misure H45 x L32 x W32 cm
Measures

Finiture GS IL OV
Finishing

**Luce 1x E27 32W light bulb,
Rgw 3,8w Induction Rechargeable**
Light

No luce
No light

Misure diametro 70cm
Measures

Finiture VT HPL
Finishing

Bart sgabello
Bart stool

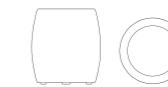

Bart fusto tavolo
Bart table base



Bart top
Bart top

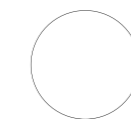

PAN DORA

E' la natura ad ispirare le forme di Pandora, che vivono del riverbero della loro texture minimale.

Entità eteree che grazie alle numerose combinazioni cromatiche e finiture creano un set di sedute e tavolini informali.

It's the nature inspiring the shapes of Pandora, that live in the echoes of their minimal texture.

Ethereal entities that thanks to the numerous chromatic combinations and finishing compose a set of informal chairs and tables.

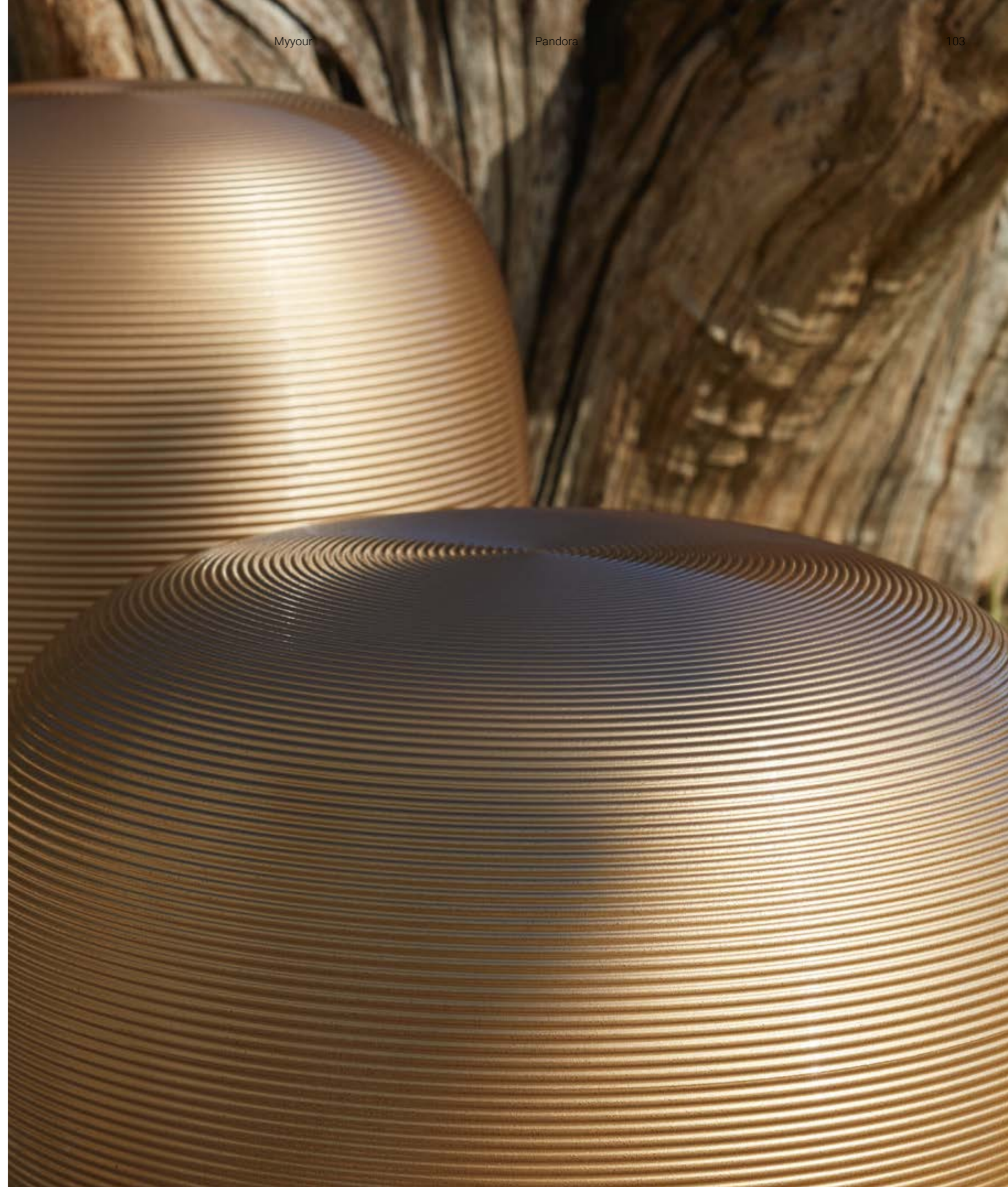

Sgabelli e tavoli Pandora
Pandora stools and tables

Lampade Pandora piantana S, M, L - catalogo luci
Pandora S, M, L standing lamp - lights catalogue





Pandora sgabello S, M
Pandora stools S, M

Pandora tavolo, Pandora sgabello M
Pandora table, Pandora M stool

Misure H31 x L55 cm
Measures

Finiture GS IL OS OV
Finishing

Luce 1x E27 32W light bulb,
Light **Rgbw 3,8w Induction Rechargeable**

No luce
No light

Pandora sgabello S,
Pandora stool S,

Pandora tavolo
Pandora table



Misure H44 x L44 cm
Measures

Finiture GS IL OS OV
Finishing

Luce 1x E27 32W light bulb,
Light **Rgbw 3,8w Induction Rechargeable**

No luce
No light

Pandora sgabello M
Pandora stool M

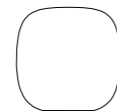

Misure H70 x L40,5 cm
Measures

Finiture GS IL OS OV
Finishing

Luce 1x E27 32W light bulb,
Light **Rgbw 3,8w Induction Rechargeable**

No luce
No light

Pandora sgabello L
Pandora stool L



OXF ORD

Oxford sgabello grazie alle sue geometrie dissimula il materiale plastico di cui è composto ricordando la classica forma dello sgabello treppiede in legno. Oxford tavolo è un tavolo alto con la possibilità di scegliere il piano tra tondo in Poleasy oppure rotondo o quadrato in HPL. Lo smontaggio delle gambe assicura inoltre un contenuto volume di trasporto e stoccaggio.

Oxford stool due to its geometry conceals the plastic material of which it is composed recalling the classical form of the wooden tripod stool. Oxford table is a high table with the possibility to choose a round Poleasy top or a round or square HPL top. Disassembly of the legs ensures also a limited volume of transport and storage.



Sgabelli e tavoli Oxford
Oxford table and stools



Sgabelli e tavoli Oxford
Oxford table and stools





Misure H75 x L34 x W34 cm
Measures

Finiture GS
Finishing

Oxford Sgabello
Oxford Stool

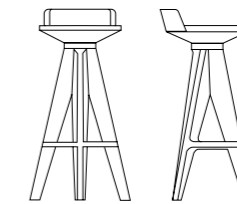

Misure H110 x L70 x W70 cm
Measures

Finiture GS HPL
Finishing

Tavolo Oxford
Oxford Table

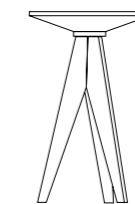

LIBE RTY

La vivacità di Liberty nasce dal gioco dei vuoti e dei pieni. Gli ampi fori nel tronco cavo esaltano, con la loro asimmetria, l'energia della superficie bicolore. Perfettamente impilabili, sgabelli e tavoli Liberty occupano e liberano l'ambiente con un originale tocco di design.

Liberty liveliness depends on the empty and full space perfect mixing. The wide holes in the empty cone frustum enhance, with their asymmetry, the bicolor surface. Perfectly stackable, Liberty stools and tables furnish and free the ambience with an original design touch.





Sgabelli Liberty L
Liberty L stools

Sgabelli Liberty L e tavoli Liberty XL
con piano D70 in HPL core bianco
Liberty L stools and Liberty XL table with HPL
white core D70 top.



Misure H45 x L33 x W33 cm
Measures

Finiture GS
Finishing

Liberty sgabello S
Liberty stool S

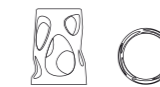

Misure H64 x L41 x W41 cm
Measures

Finiture GS
Finishing

Liberty sgabello M
Liberty stool M

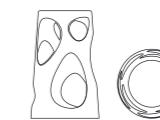

Misure H74 x L42 x W42 cm
Measures

Finiture GS
Finishing

Liberty sgabello L
Liberty stool L

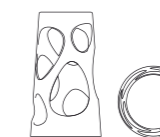

Misure H74 x L42 x W42 cm
Measures

Finiture GS
Finishing

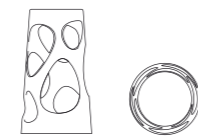

Liberty fusto tavolo L
Liberty table base L

Misure H105 x L50 x W50 cm
Measures

Finiture GS
Finishing

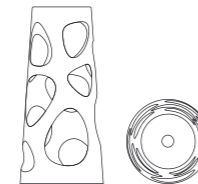

Liberty fusto tavolo XL
Liberty table base XL

Misure diametro 70 cm
Measures

Misure diametro 90 cm
Measures

Finiture VT HPL
Finishing

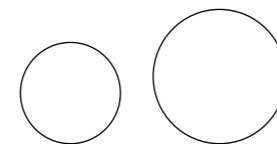

Liberty piano rotondo
Liberty round top



NOVA BAN CONE

La leggerezza e l'essenzialità nelle linee sono il leit motif di tutta la collezione Nova.

Trasportate nel mondo dei banconi bar, esse permettono a Myyour di arricchire la famiglia di quest'ultimi con altri due elementi dal design elegante e dalla versatilità sorprendente.

Senza luce, illuminati o con la finitura OV, i banconi Nova impreziosiscono il luogo che li accoglie, senza appesantire lo sguardo di chi si ne serve, sia esso operatore o cliente.

La cocktail station dedicata, infine, permette di disporre in maniera ordinata degli ingredienti necessari per accendere le grandi serate di festa.

The lightness and essentiality of the lines are the leitmotif of the entire Nova collection.

Transported to the world of bar counters, they allow Myyour to enrich the latter's family with two other elements of elegant design and surprising versatility.

Without light, illuminated or with the OV finishing, the Nova counters embellish the place that welcomes them, without weighing down the look of those who use it, be it operator or customer.

Finally, the dedicated cocktail station allows to order the ingredients needed for turning on the big party nights.

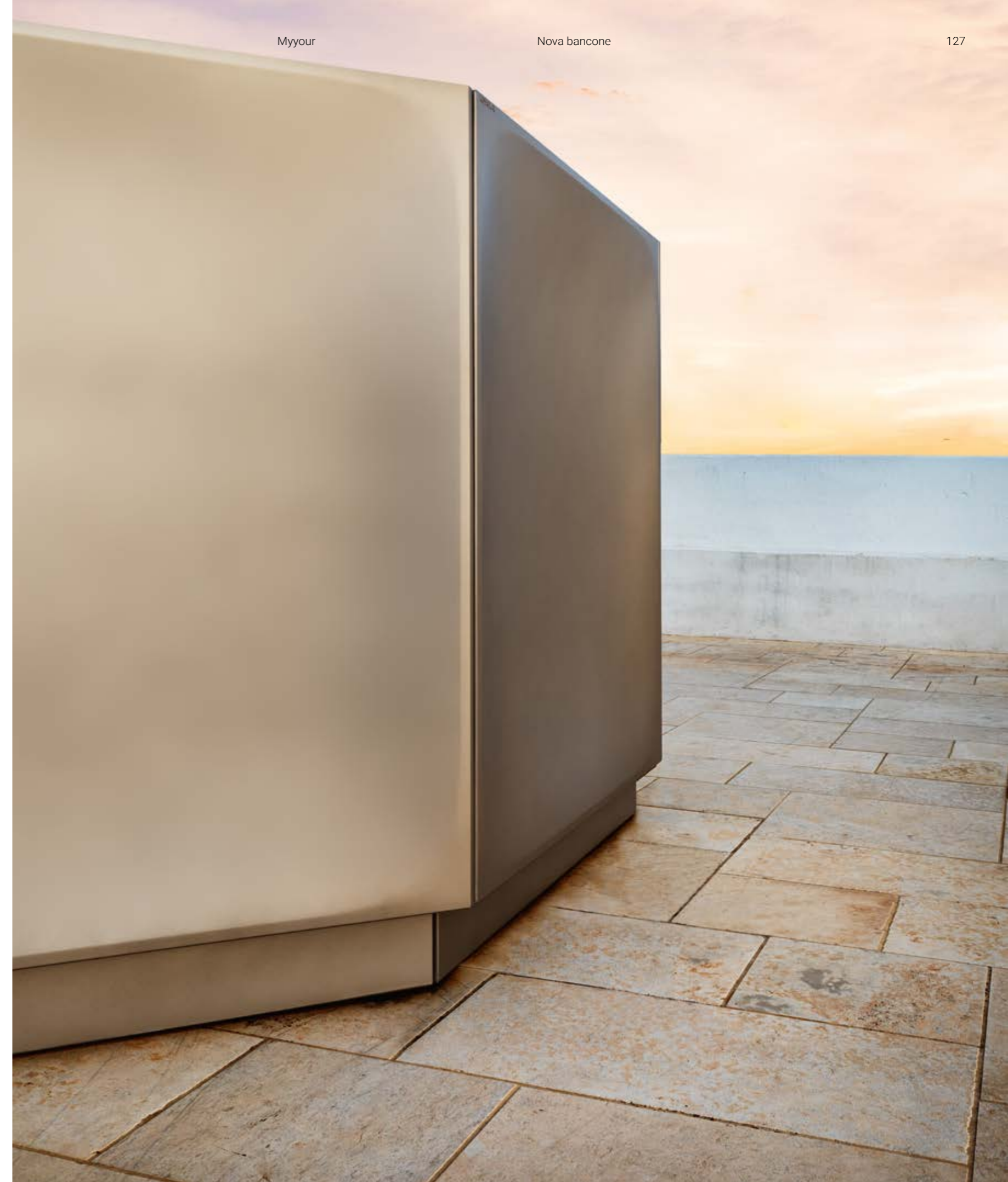







Nova bancone modulare
Nova bancone modular

Nova bancone bar
Nova bancone counter bar



Nova bancone cocktailstation
Nova bancone cocktailstation

Nova bancone bar
Nova bancone bar counter





Misure H110 x L100 x W770 cm
Measures

Finiture GS LV OS IL
Finishing

Cocktail station ABS
Cocktail station

Nova Lineare con cocktail station
Nova Straight with cocktail station

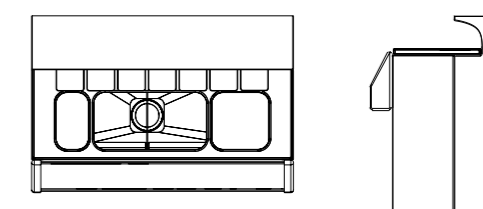

Misure H110 x L100 x W65 cm
Measures

Finiture GS LV OS IL
Finishing

Nova Lineare
Nova Straight

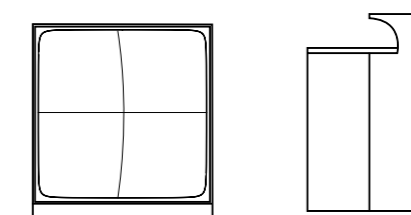

Misure H110 x L90 x W65 cm
Measures

Finiture GS LV OS IL
Finishing

Nova Angolare
Nova Corner

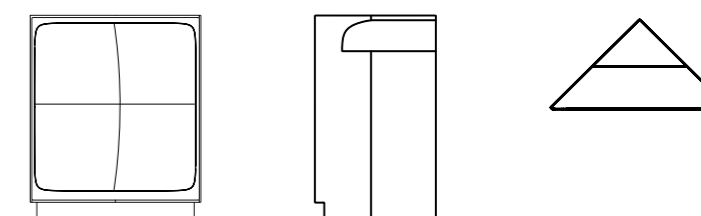

DUB LIN

Dublin è all'occorrenza bancone bar, modulo cassa e reception le cui forme sono ispirate ai banconi dei vecchi pub irlandesi.

I fianchi richiudibili per il modulo lineare, la possibilità di personalizzare la facciata, i diversi tipi di illuminazione e la sua maneggevolezza rendono Dublin uno strumento perfetto per qualsiasi situazione.

Dublin is if needed bar counter, cash and reception module, whose shapes are inspired by the counters of the old Irish pub.

The closable sides for the straight module, the possibility to customize the facade, the different types of lighting and ease of handling, make Dublin a perfect tool for any situation.





Bancone bar Dublin
Dublin bar counter

Dublin specifiche tecniche pag. 324
Dublin tech specs page 324

Tavoli e sgabelli Oxford pag. 110
Oxford table and stools page 110



Bancone bar Dublin e sgabelli Oxford
Dublin bar counter and Oxford stools

Dublin specifiche tecniche pag. 324
Dublin tech specs page 324

Sgabelli Oxford pag. 110
Oxford stools page 110



Dublin bancone bar versione ossidato
Dublin bar counter oxidated version

Dublin specifiche tecniche pag. 324
Dublin tech specs page 324

Sgabello Oxford pag. 110
Oxford stool page 110



Bancone Dublin bar
Dublin bar counter

Frontale personalizzabile
Customizable face element



Misure H110 x L100 x W770 cm
Measures

Finiture GS LV OS IL
Finishing

Cocktail station ABS
Cocktail station

Dublin Lineare con cocktail station
Dublin Straight with cocktail station

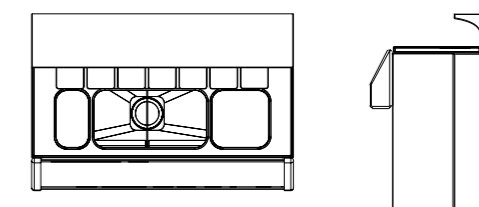

Misure H110 x L100 x W65 cm
Measures

Finiture GS LV OS IL
Finishing

Luce 2x E27 32W
Light **RGBW Led Strip,**
RGBW Cable Rechargeable

No luce
No light

Dublin Lineare
Dubling Straight

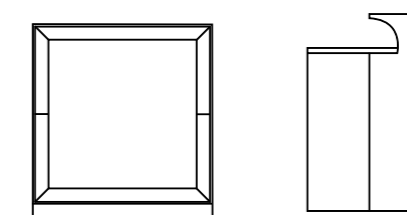

Misure H110 x L90 x W65 cm
Measures

Finiture GS LV OS IL
Finishing

Luce 2x E27 32W
Light **RGBW Led Strip,**
RGBW Cable Rechargeable

No luce
No light

Dublin Angolare
Dublin Corner

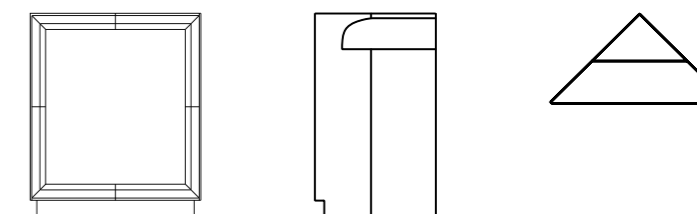

BAR A ONDA

Immaginate un'onda plastica e sinuosa che si materializza in un bancone; immaginate di poterla liberamente comporre in svariate forme e colori; immaginate di farla vivere e vibrare con i più fantasiosi effetti cromatici e luminosi; immaginate infine di poterla ripiegare su se stessa per trasportarla ovunque vi serva, o metterla da parte.

Baraonda è tutto questo: un bancone da bar difficile da collocare in una categoria predefinita, perché ne crea una totalmente nuova.

Imagine a plastic and sine wave turned into a counter; imagine to be freely able to mix it in different shapes and colours; imagine to live and vibrate it with the many different bright and lively colours; finally imagine to be able to fold it on itself to move it everywhere or put it aside.

Baraonda is all these things: a bar counter difficult to place in a specific category, as it creates a totally new one.





Baraonda bancone bar
Baraonda bar counter

Display pag. 160
Display page 160

Baraonda specifiche tecniche pag. 332
Baraonda tech specs page 332



Baraonda bancone modulare
Baraonda modular counter

Misure H110 x L160 x W33+65 cm
Measures

Finiture GS LV OS IL
Finishing

Luce white led strip, RGBW led strip, 2x E27 32W bulb
Light

No luce
No light

Baraonda cocktail station
Baraonda cocktail station

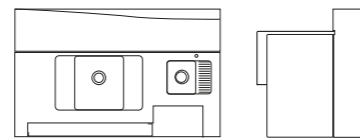

Misure H110 x L160 x W33+57 cm
Measures

Finiture GS LV OS IL
Finishing

Luce white led strip, RGBW led strip, 2x E27 32W bulb
Light

No luce
No light

Baraonda 60
Baraonda 60

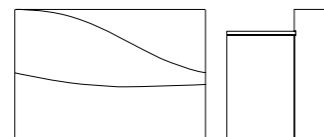



Misure H110 x L90 x W90 cm
Measures

Finiture GS LV OS IL
Finishing

Luce white led strip, RGBW led strip, 2x E27 32W bulb
Light

No luce
No light

Baraonda Curva 60
Baraonda Corner 60

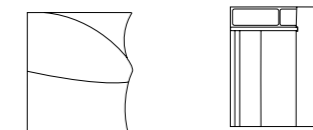

DIS PLAY

Nasce come modulo di Baraonda sia per tenere le bottiglie giuste nel retrobanco che per arredare l'ambiente domestico come libreria.

It was born as a Baraonda module both to store the right bottle in the back-counter and to furnish the domestic environment as a library.





Lampada Bell - catalogo luci
Bell suspension lamp - lights index

Tavola Teddy
Teddy table

Sgabelli Bart
Bart stools



Misure H205 x L80 x W45 cm
Measures

Finiture GS LV IL
Finishing

Luce noLight, RGBW Led Strip, White Led Strip
Light

Display verticale
Display vertical

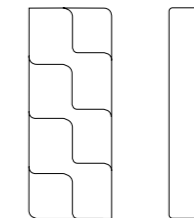

KITE

Elegante ed evocativo come una vela Kite è la struttura ideale per ospitare le feste in giardino, per i ristoranti all'aperto, per i locali di qualsiasi tipo.

Elegant and evocative as a sail Kite is the ideal place to host a party in the garden, for outdoor restaurants, for clubs of any kind.





Kite
Kite

Sedie Lily pag. 12
Lily chair page 12

Tavoli Teddy
Teddy tables

Lampada Agata wood - catalogo luci
Agata wood standing lamp - lights catalogue

Sgabelli e tavoli Liberty pag. 118
Liberty stools and tables page 118



Kite 6 x 6
Kite

Display pag. 160
Display pag3 160

Bancone bar Baraonda
Baraonda bar counter

Misure H350 x L300 x W300 cm, diametro 15 cm
Measures

Struttura in alluminio e acciaio verniciato bianco
copertura in pvc
White painted aluminum and steel structure
with pvc ceiling

Piastre portanti necessarie
Self Supporting plates needed

Kite 3x3
Kite 3x3

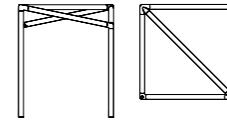

Misure H350 x L400 x W400 cm, diametro 15 cm
Measures

Struttura in alluminio e acciaio verniciato bianco
copertura in pvc
White painted aluminum and steel structure
with pvc ceiling

Piastre portanti necessarie
Self Supporting plates needed

Kite 4x4
Kite 4x4

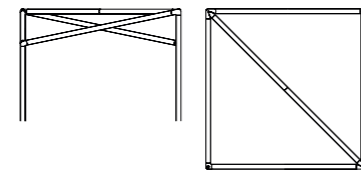

Misure H350 x L500 x W500 cm, diametro 15 cm
Measures

Struttura in alluminio e acciaio verniciato bianco
copertura in pvc
White painted aluminum and steel structure
with pvc ceiling

Piastre portanti necessarie
Self Supporting plates needed

Kite 5x5
Kite 5x5

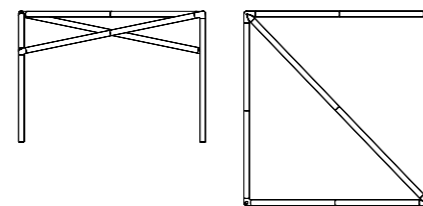

Misure H350 x L600 x W600 cm, diametro 15 cm
Measures

Struttura in alluminio e acciaio verniciato bianco
copertura in pvc
White painted aluminum and steel structure
with pvc ceiling

Piastre portanti necessarie
Self Supporting plates needed

Kite 6x6
Kite 6x6

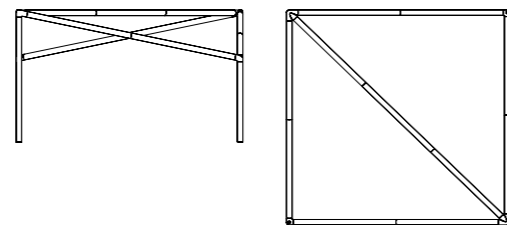

NON VASO

Non essere vaso, ma anche esserlo nella sua essenza/assenza non è un dilemma intellettuale, ma un'idea aperta a infinite possibilità.

Il vuoto come spazio libero, svincolato dalla tristezza della materia, ispiratore nella forma, surreale ma presente, concreto e reale.

Lampo di intuizione per ampliare la percezione: dentro, oltre, attraverso. Ma non era un vaso?

Not being a pot, but also being it in its essence/absence: not an intellectual dilemma, but an idea opened to endless possibilities.

The emptiness as a free space, free of the sadness of the matter, with an inspiring form, surreal but present, concrete and real.

Eureka moment to extend the perception: inside, over, through. But wasn't it a pot?





Nonvaso
Nonvaso

Sgabelli e tavoli Oxford pag. 110
Oxford stools and tables page 110

Bancone bar Dublin pag. 138
Dublin bar counter page 138



**Misure H90 x L100 x W35 cm**

Measures

Finiture GS OS IL

Finishing

Luce 2X E27 32W 2X RGBW 3,8Wcable rechargeable

Ligth

No luce

No lighth

Nonvaso

Nonvaso

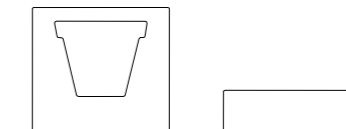
**Misure H90 x L100 x W35 cm**

Measures

Finiture GS OS IL

Finishing

Luce 2X E27 32W 2X RGBW 3,8Wcable rechargeable

Ligth

No luce

No lighth

Nonvaso con foro

Nonvaso with hole

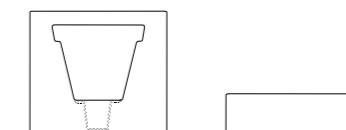
**Misure H57 x L38**

Measures

Finiture Plexiglass

Finishing

Luce 2X E27 32W 2X RGBW 3,8Wcable rechargeable

Ligth

No luce

No lighth

Nonvaso pannello decorativo

Nonvaso decorative panel



FRA MES

Frames è un modulo utilizzabile come separatore di spazi, recinzione o rivestimento, sia in posizione orizzontale che verticale con l'ausilio delle apposite zavorre.

La composizione è caratterizzata da superfici svasate che fanno da cornice a piccole finestre, rendendole dei piacevoli scorci geometrici

Frames is a module used as a room divider, fence or paneling, both in horizontal and vertical position through the use of its specific ballasts.

The composition is characterized by flared surfaces that are the framework for small windows, making them pleasant geometric glimpses.





Separatore Frames
Frames dividing wall



Frames
Frames

Poltrone e divano 2054 imbottito pag. 38
2054 padded sofa and armchairs page 38



Frames piastra autoportante in metallo
Frames self supporting metal plate

Separatore Frames, sgabelli Pandora S, M, L
Frames dividing wall. Pandora S, M, L stools

Misure H35 x L53 cm

Measures

Finiture ML

Finishing

Frames piastra autoportante
Frames self supporting plate

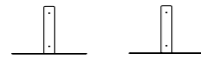

Misure H48 x L57 cm

Measures

Finiture GS

Finishing

Frames zavorre
Frames ballastsv

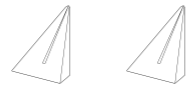

Misure H1500 x L20 x W8 cm

Measures

Finiture GS

Finishing

Frames
Frames

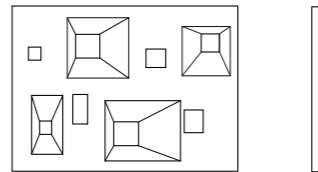

BA
GI
GIO

Un elemento componibile, unico ma aggregabile senza limite, rappresentazione tridimensionale del simbolo dell'infinito, nato dalla rivoluzione dello stesso intorno al proprio asse e al contempo macroimmagine spaziale di un legame atomico bipolare. Bianco, colorato, capace di accendersi di luce propria.

Con gli elementi Ba_gigio, oltre alle pareti divisorie si possono creare tavoli di diverse dimensioni con e senza luce.

A modular element, unique yet capable of being joined with anything without limits, a three-dimensional representation of the symbol for infinity, born from the revolution of the symbol around its axis and at the same time a spatial macro image of a bipolar atomic link.

White or coloured, capable of lighting up on its own.

Beyond dividing walls, with Ba_gigio elements it's possible to create tables in different sizes with and without lights.





Parete Ba_gigio con luce
Ba_gigio wall with light
Ba_gigio specifiche tecniche
Ba_gigio tech specs



Parete Ba_gigio con luce
Ba_gigio wall with light

Ba_gigio specifiche tecniche
Ba_gigio tech specs

Tavolo Trigigio
Trigigio table

Poltrone imbottite 2054 pag. 38
2054 padded armchairs page 38



Misure L80 x W85 cm
Measures

Finiture VT
Finishing

Trigigio piano in vetro
Trigigio glass top

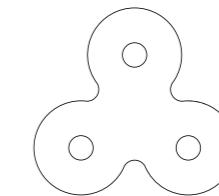

Misure H28,5 x L30 x W30 cm
Measures

Finiture GS LV
Finishing

Gigio
Gigio

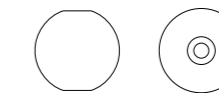

Misure H28,5 x L30 x W18 cm
Measures

Finiture GS LV
Finishing

Nocciolina
Nocciolina

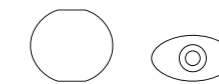

Misure H28,5 x L91 x W31 cm
Measures

Finiture GS LV IL
Finishing

Ba_gigio
Ba_gigio

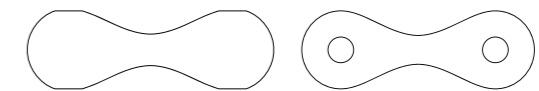

CLOE

Le sue curve morbide, suadenti e mai esasperanti, sono l'estrema sintesi di questo lettino che danno comfort ed un alto livello di benessere. Cloe è realizzata in Poleasy e studiata per una collocazione in ambienti esterni, resistendo all'acqua ed ai raggi UV.

Its soft, smooth and never exasperating curves are the ultimate synthesis of this sunbed that give comfort and a high well-being perceived. Cloe is made in Poleasy, designed for outdoor spaces being resistant to water and UV rays.





Lettino Cloe
Cloe sunbed

Mr Lem sgabello / fusto per tavolo pag. 88
Mr. Lem stool / table base page 88



Letfino Cloe
Cloe sunbed

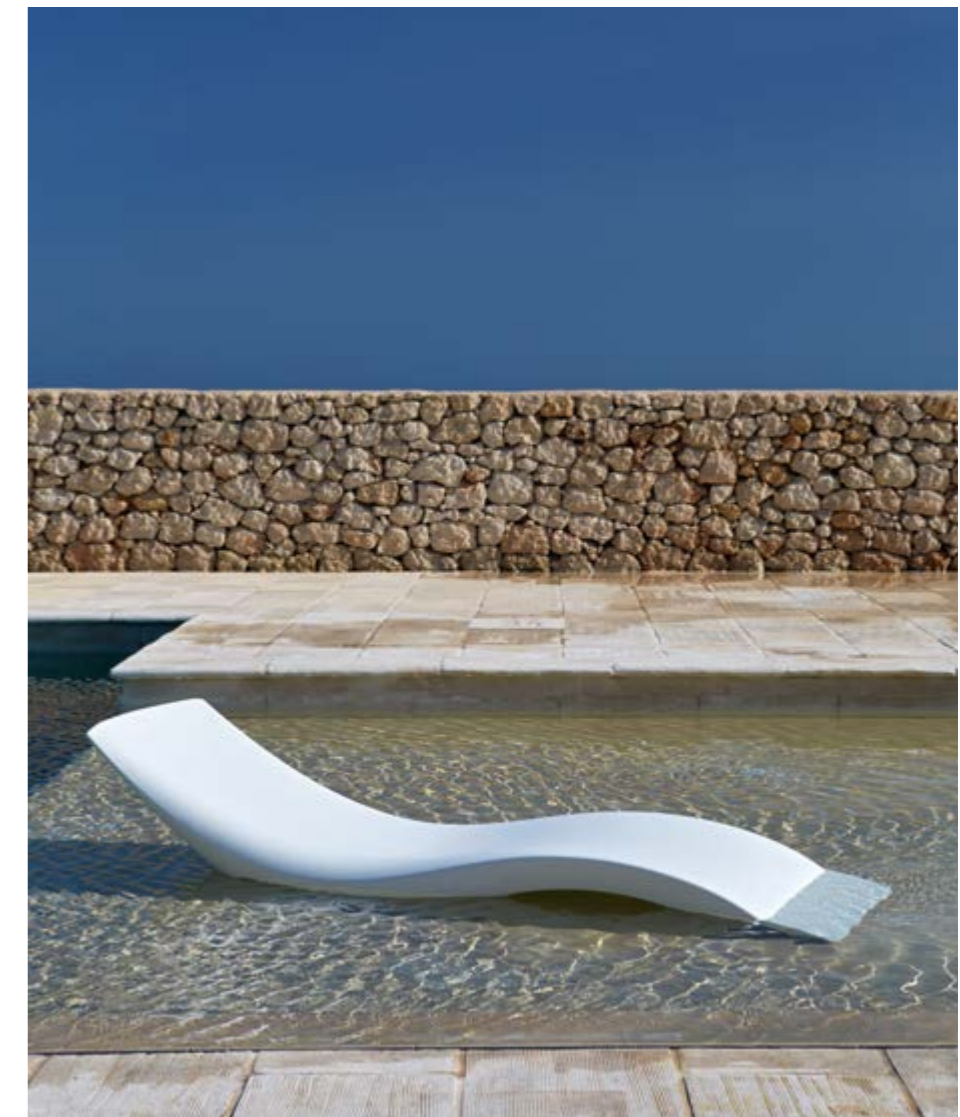

Lettino Cloe
Cloe sunbed

Misure H54 x L220 x W69 cm
Measures

Finiture GS LV EC
Finishing

Spugna H5 x L225 x W55 cm
Sponge towel

Cloe lettino
Cloe sunbed

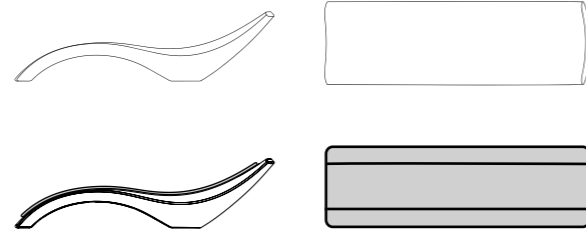

ZOE

Un'idea sofisticata, elegante e con finiture di alto livello come ad esempio la versione rivestita.

Il design di Zoe si integra armoniosamente con il sistema di regolazione dello schienale risolto con l'impiego di un pistone a gas azionabile da un semplice pulsante.

La scocca in Poleasy contiene dispositivi metallici interamente cromati che garantiscono una lunga totale resistenza agli agenti atmosferici.

A sophisticated and elegant idea with high quality finishes, as in upholstered version.

Zoe's design harmoniously blends in with the back adjustment system by means of a gas piston, which can be activated by simply pushing a button. The Poleasy shell contains metallic devices that are entirely chromed and which guarantee a long and complete level of resistance against atmospheric conditions.





Letini Zoe
Zoe sunbeds



Letfini Zoe
Zoe sunbeds

Mr Lem sgabello / fusto per tavolo pag. 88
Mr. Lem stool / table base page 88



Misure H59 x L223 x W69 cm
 Measures

Finiture GS LV EC
 Finishing

Spugna H5 x L225 x W55 cm
 Sponge towel

Zoe
 Zoe

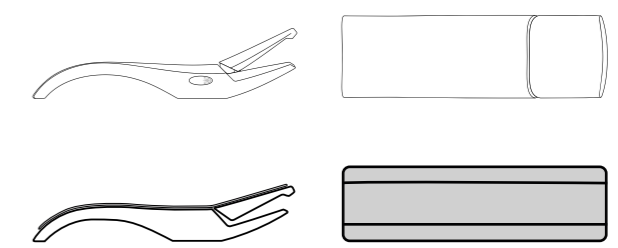

NOVA LETTINO

Nova lettino nasce dalla ricerca di una linea pulita ed essenziale che dia vita ad un oggetto elegante e futuristico ma allo stesso tempo pratico grazie all'impilabilità e alle facilità di movimentazione con le ruote.

Nova sunbed borns from the research of a clean and essential line that gives life to an elegant and futuristic sunbed contemporary practical thanks to the stackability and the easy of handling on wheels.





Lettino Nova
Nova sunbed



Lettini Nova con cuscino
Nova sunbed with cushions

Misure H29 x L215 x W94 cm
Measures

Finiture GS
Finishing

Lettino Nova
Nova sunbed

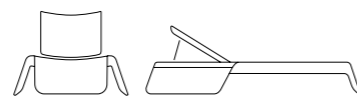

Misure H29 x L215 x W94 cm
Measures

Finiture GS TE sunbrella
Finishing



Lettino Nova con cuscino
Nova sunbed with cushion

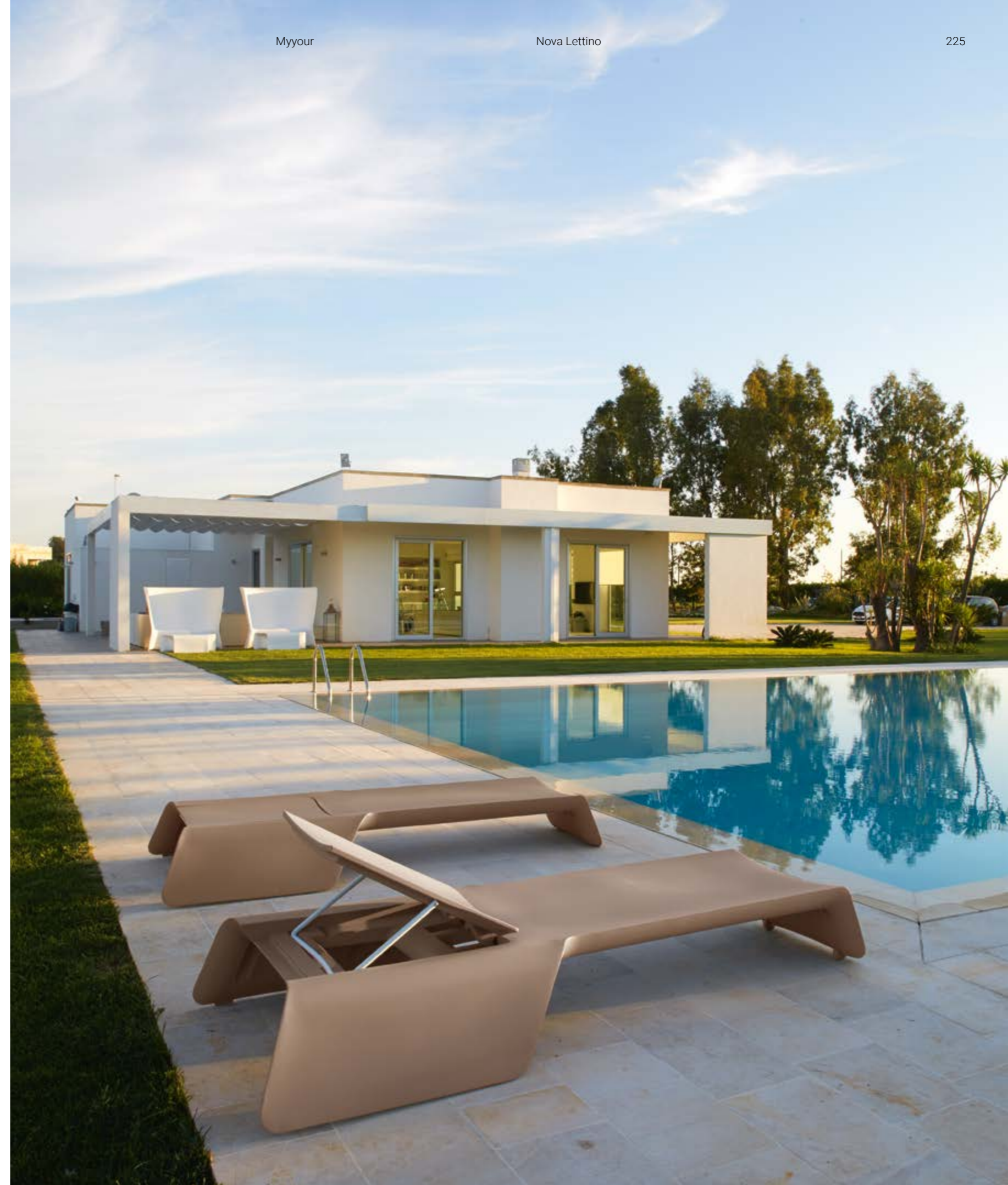

DYNO

Una forte personalizzazione del giardino e del bordo piscina sono gli obiettivi che ci hanno guidato nel progetto Dyno.

La doccia Dyno è disponibile in tutti i colori nelle versioni goffrato stampato o verniciato lucido.

La base Paw realizzata in ABS è dotata di profili per trattenere la sabbia ed è rivestita con un film acrilico che rende più comode e sicure le operazioni di pulizia.

A strong personal touch to the garden and poolside is the objective that guided us throughout our Dyno project.

The Dyno shower is available in all colors for both the embossed moulded or painted versions.

The Paw base is made with ABS and it has special profiles that make keeping sand out possible. It is covered with an acrylic film to make the cleaning operations more comfortable and safe.





Doccia Dyno e piatto
Dyno shower and Paw shower tray

Lettino Nova pag. 218
Nova sunbed page 218



Misure H6,5 x L112 x W85 cm
Measures

Finiture ABS bianco/white Abs
Finishing

Misure H230 x L38 x W89 cm
Measures

Finiture GS LV
Finishing

Paw piatto doccia
Paw shower tray



Dyno doccia
Dyno shower

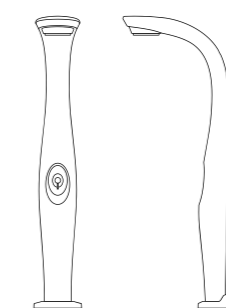

PAN DORA POTS

Forme semplici caratterizzate dalla texture Pandora danno vita a questo elegante set di vasi, utilizzabili sia singolarmente che come trittico, o in gruppo come separatori di spazi.

Illuminati, i vasi Pandora vivono del riverbero della loro texture minimale, conferendo un tocco di stile ad ogni ambiente.

Simple shapes characterized by the Pandora texture give life to this elegant set of pots, usable either individually or as a triptych, or in group like space separators.

If lighted, Pandora pots live by the reverberation of their minimal texture, giving a touch of style to any location.





Pandora fioriera
 Pandora plant box
 Poltrone Netwood - catalogo Soften
 Netwood armchairs - Soften catalogue



Pandora Ice Box
Pandora Ice Box

Divano e tavolo Samurai Plusline
Samurai Plusline sofa and table

Pandora vasi S, M, e Ice Box
Pandora S, M, pots and Ice Box

Misure H78 x L45-25 x W45-25 cm
Measures

Misure foro H26 x L25 x W25 cm
Hole measures

Finiture GS OV IL
Finishing

Luce 1xE27, 1xRGBW 3,8W cable rechargeable
No light

Pandora vaso S
Pandora pot S

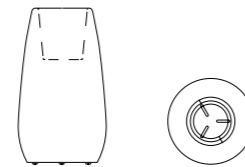

Misure H98 x L45-25 x W45 cm
Measures

Misure foro H26 x L25 x W25 cm
Hole measures

Finiture GS OV IL
Finishing

Luce 1xE27, 1xRGBW 3,8W cable rechargeable
No light

Pandora vaso M
Pandora pot M

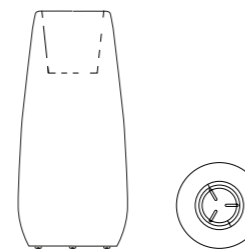

Misure H78 x L118 x W45 cm
Measures

Misure foro H26 x L99 x W26 cm
Hole measures

Finiture GS OV IL
Finishing

Luce 2xE27, 2xRGBW 3,8W cable rechargeable
No light

Pandora fioriera / Ice box
Pandora plant box / Ice box

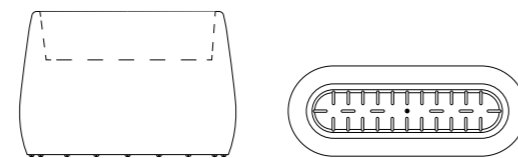

SKIN

Skin è una famiglia di vasi dalla forma lineare, il suo fascino si cela dietro la sua texture che scatena il desiderio di sfiorarli.

L'esclusiva finitura trae ispirazione dall'osservazione dei particolari di cui vive l'ambiente naturale, che rivela dettagli e geometrie apparentemente invisibili ma non insignificanti: ogni cosa ha una sua pelle.

Skin is a pot family with linear shapes and its charm is blind behind its texture inciting the desire to touch them.

Its exclusive finishing take inspiration from the observation of particulars of which lives the natural environment that reveal details and geometries apparently invisible but not without importance: everything has its own skin.

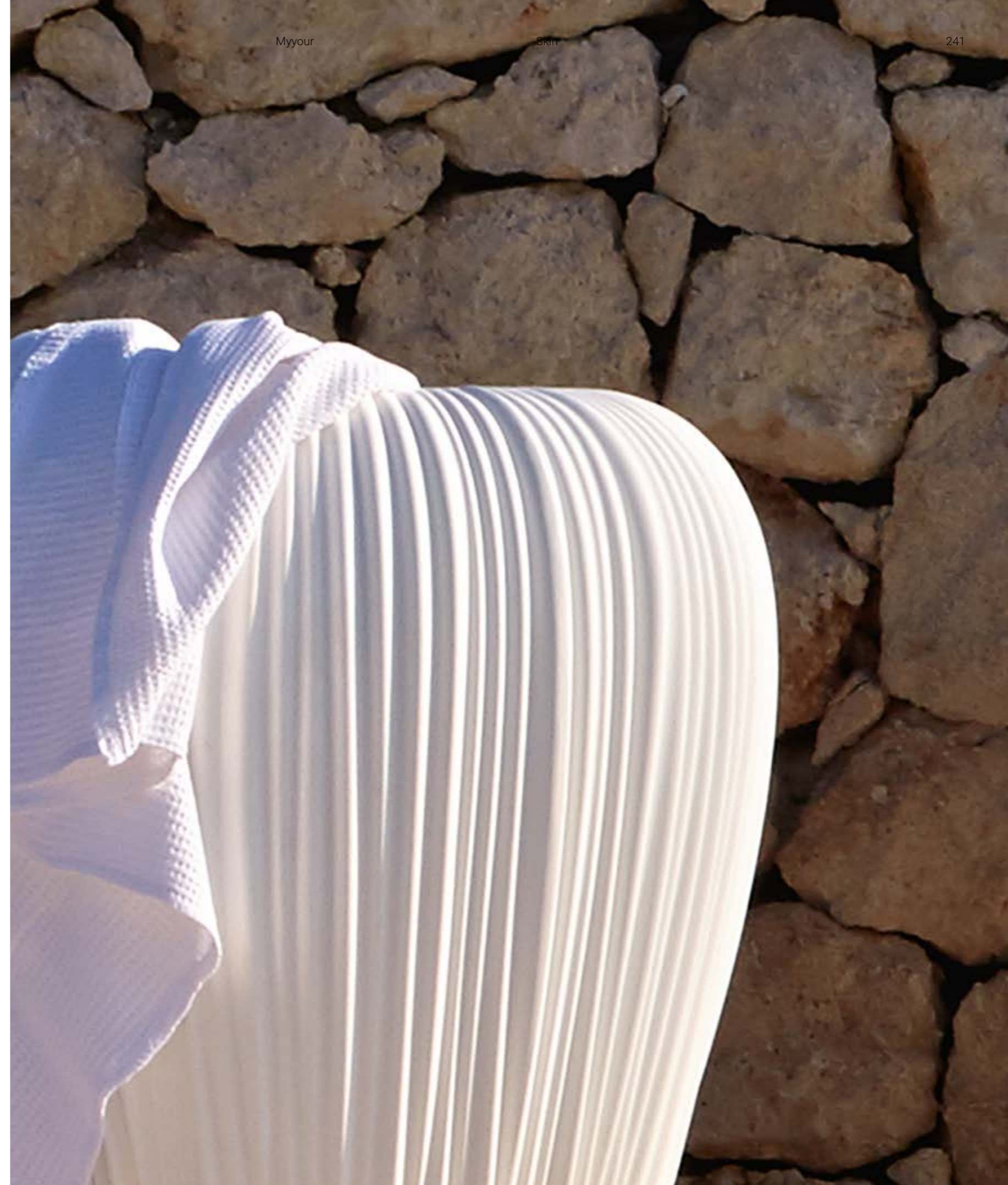



Skin L con finitura ossidato Ruggine OS
 Skin L in OS Rust oxidized finishing

Skin S, L con finitura ossidato Rame OS
 Skin S, L in OS Copper oxidized finishing



Skin S, L illuminati
 Skin S, L with light





Misure H60 x L55 x W55 cm
Measures

Misure foro H23,5 x L32 x W32 cm
Hole measures

Finiture GS LV OV OS IL
Finishing

Luce 1x E27 32W,
3,8w RGBW induction rechargeable
Ligth

No lighth
No lighth

Vaso Skin S
Skin Pot S



Misure H120 x L60 x W60 cm
Measures

Misure foro H23,5 x L32 x W32 cm
Hole measures

Finiture GS LV OV OS IL
Finishing

Luce 1x E27 32W,
3,8w RGBW induction rechargeable
Ligth

No lighth
No lighth

Vaso Skin L
Skin Pot L

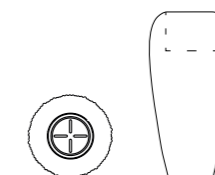

GEM

I vasi Gem si ispirano al taglio delle pietre preziose, dal micro al macro, giocando sul filo dell'esagerazione.

Oggetti dove il dettaglio di un segno solitamente microscopico diventa l'elemento distintivo che caratterizza l'intera collezione in tutti i suoi formati. Arredi la cui presenza monolitica e raffinata diventa protagonista riuscendo ad adattarsi in maniera quasi camaleontica agli stili di ambienti più diversi.

Oggetti allo stesso tempo eleganti o informali, per interni o esterni, per uso domestico o contract capaci di valorizzare con la loro presenza qualsiasi contesto.

Gem pots are inspired by the cut of precious stones, from the micro to the macro, playing on the edge of exaggeration.

Objects where the detail of a usually microscopic sign becomes the distinctive element that characterizes the entire collection in all its formats. Furniture whose monolithic and refined presence becomes the main character, managing to adapt in an almost chameleonic fashion to the styles of different locations.

Objects that are at the same time elegant or informal, for indoor or outdoor, for home or contract use, able of enhancing any context with their presence.





Vasi Gem M e fioriere
Gem pots M and plant boxes

Lettini Nova pag. 218
Nova sunbeds page 218



Gem icebox nella finitura direct painting OV
 Gem icebox in OV direct painting finishing

Vaso Gem S e M nelle finitura OV
 Gem S and M pot, OV finishing



Vasi Gem S, M e fioriera
Gem pots S, M and plant box

Gem ice box e divano Nova S illuminato
Gem ice box and ligthed Nova S sofa





Misure H53 x L50 x W50 cm
Measures

Misure foro H29 x L33 x W33 cm
Hole measures

Finiture GS OV IL
Finishing

Luce 1xE27, 1xRGBW 3,8W cable rechargeable
Light

No luce
No Light

Gem vaso S
Gem pot S

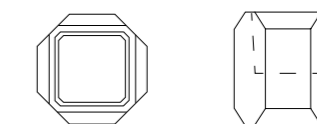

Misure H120 x L50 x W50 cm
Measures

Misure foro H30 x L33 x W33 cm
Hole measures

Finiture GS OV IL
Finishing

Luce 1xE27, 1xRGBW 3,8W cable rechargeable
Light

No luce
No Light

Gem vaso M
Gem pot M

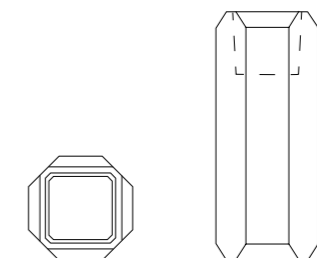

Misure H80 x L120 x W40 cm
Measures

Misure foro H30 x L103 x W23 cm
Hole measures

Finiture GS OV IL
Finishing

Luce 2xE27, 2xRGBW 3,8W cable rechargeable
Light

No luce
No Light

Gem fioriera / Ice Box
Gem pot plant / Ice box

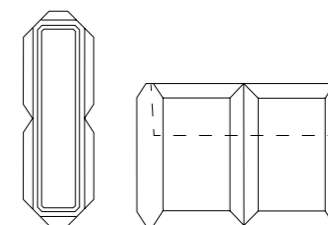

AMPO ULE

Una goccia di luce, una forma archetipa e pura che nel suo dinamico slancio racconta l'ineguagliabile poesia del dono di un fiore.

Questo il pensiero ispiratore di un vaso gigante per un unico fiore, un'opera che caratterizza ogni spazio con la sua semplicità, raccontando la magia della sua storia.

Il set comprende anche Ampoule S, per una presenza elegante a centro tavola.

A drop of light, an archetypal and pure form that in its dynamic impetus tells of the unique poem of a flower gift.

This is the inspiring thought of a giant vase for a single flower, a work that characterises every space with its simplicity, telling the magic of its history.

The set also includes Ampoule S, an elegant presence in the middle of the table.





Ampoule XL versione RGBW ricaricabile
Ampoule XL RGBW rechargeable version



Ampoule S, versione RGBW ricaricabile
Ampoule S, RGBW rechargeable version

Ampoule S
Ampoule S



Misure H35 x L15,5 cm
Measures

Finiture GS LV OS IL
Finishing

Luce 1x G9 led 1W
Light **Led RGBW 1W induction Rechargeable**
no light

Ampoule S
Ampoule S

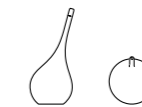

Misure H205 x L58
Measures

Finiture GS LV OS IL
Finishing

Luce 1x E27 32W light bulb
Light **Led RGBW 5W cable Rechargeable**
no light

Ampoule XL
Ampoule XL

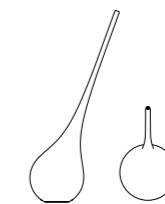

TAO

Tao è un sistema di vasi che si propone di eliminare tale schiavitù geometrica, ispirandosi ai concetti ritmici dello yin e dello yang. Liberamente accostabili in gruppi di due o tre elementi, i vasi Tao sono disponibili in versione gofrata stampata, lucida verniciata ed ossidata.

Tao is a system of pots that is proposed to eliminate such geometric slavery, inspired by the rhythmic concepts of yin and yang. They can be composed in groups of two or three elements. The Tao vases are available in embossed moulded, glossy painted and oxidized version.





Vasi Tao S, M, L
Tao pots S, M, L



Misure H36 x L64 x W37 cm
Measures

Misure foro H19 x L23 cm
Hole measures

Finiture GS LV OS
Finishing

Tao Small
Tao Small

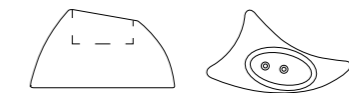

Misure H60 x L59 x W38 cm
Measures

Misure foro H23 x L29 cm
Hole measures

Finiture GS LV OS
Finishing

Tao medium
Tao medium

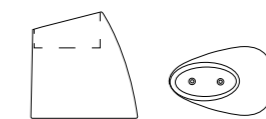

Misure H90 x L105 x W26 cm
Measures

Misure foro H30 x L46 cm
Hole measures

Finiture GS LV OS
Finishing

Tao Large
Tao Large

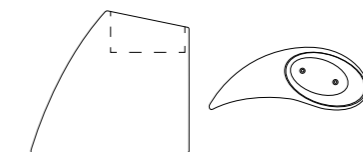

TINO

L'idea è di creare una sedia per bambini che sia anche gioco. Oggetto transazionale, richiama nel piccolo tenerezza, forza, coraggio e bellezza. La forma morbida e dolce rende l'oggetto una mascotte. La proboscide di Tino è rivolta verso l'alto diventando schienale e riprendendo la simbologia di buon auspicio per l'elefante.

The idea is to create a children's chair and a toy too. Transactional object that recalls to the little tenderness, strength, courage and beauty. The soft and sweet shape makes it a mascot. Tino's proboscis is faced up becoming the back of the chairs and refers to the auspicious symbolism of the elephant too.

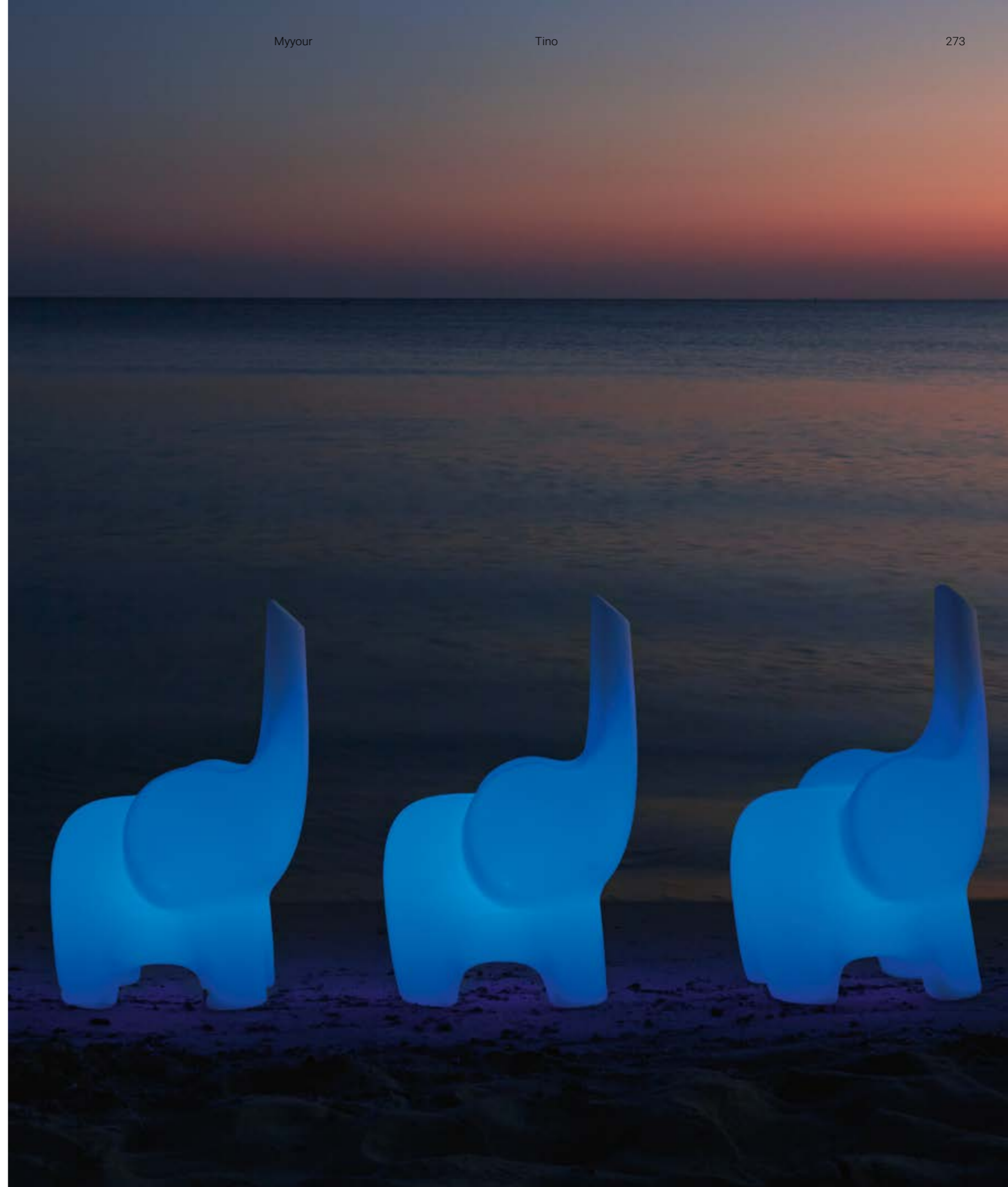



Sedia Tino
Tino chair

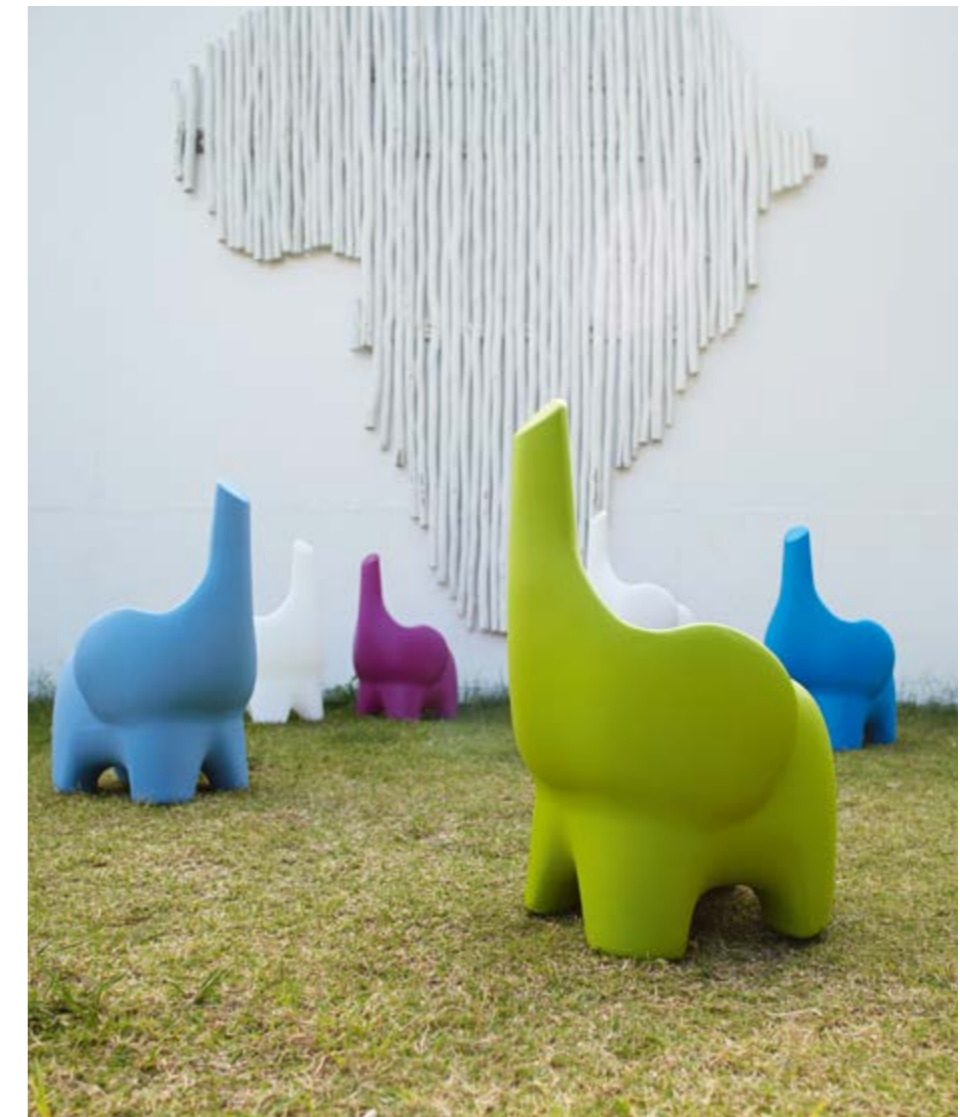

Sedia Tino
Tino chair

Misure H61x L35 x W38 cm
Measures

Finiture GS IL
Finishing

Luce 1x G9 led 1W
Led RGBW 3,2W induction Rechargeable
Ligth

No luce
No lighth

Tino

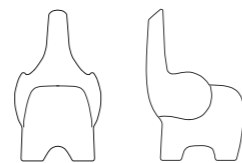

CRAZY HEAD

Un portacasco da parete con un vano svuota tasche e un gancio appendiabiti. Per gli amanti della moto, siano motociclisti professionisti o studenti al loro primo scooter, il casco è un elemento personale importante quanto la moto stessa e per questo si merita un luogo speciale dove venire riposto.

A helmet holder to hang onto the wall with a compartment for everything you carry in your pockets and a clothes hook. For motorbike lovers, whether they are professional motorcyclists or students with their first scooter, helmets are an important personal element just as much as the bike itself and for this reason they deserve a special storage place.





Crazy Head
Crazy Head



Misure H17 x L7,5 x W13 cm
Measures

Finiture GS
Finishing

Crazy Head mini
Mini Crazy Head



Misure H36 x L16 x W26 cm
Measures

Finiture GS
Finishing

Crazy Head
Crazy Head

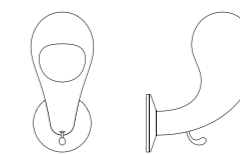

TECH INDEX

Myyour
excellences

intro
288 - 289

poleasy ®
290 - 293

Oxydized
294 - 303

Direct painting
304 - 313

Dryfeel
314 - 315

prodotti
products

Nova
316 - 319

Modi zero
320 - 323

Nova - Dublin
324 - 331

Baraonda
332 - 341

Kite
342 - 347

Bagigio
348 - 353

finiture e colori
finishes and colors

GS
basic
354 - 355

OV
direct painting
356 - 357

OS
oxidized
358 - 359

LV
glossy
360 - 361

TE
textile
362 - 363

Designers
364 - 369

EXCE LLEN CES

Se una filosofia è differente all'originale, differente sarà in tutte le sue variazioni e sviluppi. NON è un semplice teorema matematico, ma la semplice enunciazione della vision MYYOUR: uno scarto e uno scatto sempre oltre l'ovvio. una tenace sfida al pensiero immobile sostenuta da una solidissima padronanza dei materiali, dalla quale si sprigiona sempre la scintilla dell'idea. Da qui la continua evoluzione riguardo la ricerca di nuovi materiali e nuove finiture, per essere sempre un passo avanti e riconosciuti come eccellenti.

If a philosophy is different from its origins, different will be its variations and changes. It is not a math theorem, but simply Myyour vision: a gap and step forward from evidence. An hard challenge to the immobile thought, supported by a strong control of material where any idea spark always come from.

Hence the continuous evolution regarding the search for new materials and new finishes, to always be a step forward and recognized as excellent.

PO LEA SY®

Non sono solo il design e le tecnologie a fare la differenza nei prodotti MYYOUR: anche per quanto riguarda i materiali l'azienda padovana oggi è in grado di esprimere il massimo grazie a un nuovo polietilene speciale denominato Poleasy, messo a punto attraverso un lavoro di ricerca durato anni con l'obiettivo di eliminare quelle microporosità superficiali responsabili della formazione di antiestetice patine e, nel tempo, anche di possibili fessurazioni.

Poleasy, risolve definitivamente il problema garantendo alle creazioni MYYOUR superfici più compatte e performance davvero uniche in fatto di durata, lavabilità e brillantezza dei colori.

Design and technology are not the only factors that make the difference in MYYOUR products: also because, as far as the materials are concerned, this company, which is based in Padua, Italy, is able to fully express itself thanks to a new and special type of polyethylene called Poleasy.

Poleasy was developed after long years of research. In fact our research was focused on finding a way to eliminate the microporous surfaces that are responsible for the formation of anti-aesthetic patinas or cracks over time. Poleasy, has entirely solved this problem by ensuring compactness to the surfaces of MYYOUR's creations and a better performance in terms of durability, washability and color brightness.





PE



POLEASY



DIRTY



CLEAN

Poleasy, risolve definitivamente il problema garantendo alle creazioni MYYOUR superfici più compatte e performance davvero uniche in fatto di durata, lavabilità e brillantezza dei colori.

Poleasy, has entirely solved this problem by ensuring compactness to the surfaces of MYYOUR's creations and a better performance in terms of durability, washability and color brightness.

OXI DI ZED

La continua ricerca ed evoluzione porta MYYOUR a scoprire sempre nuovi orizzonti. Il different concept diventa different finishing: MYYOUR presenta l' "ossidato" nei colori rame e ruggine.

L'accurata lavorazione, che mette in simbiosi due materiali chiaramente agli antipodi, prevede l'utilizzo di particelle di ferro come rivestimento, il cui processo di ossidazione viene attivato da prodotti specifici e bloccato da un'apposita vernice trasparente, che ne permette l'utilizzo all'esterno. Così facendo il materiale plastico trasforma la sua natura diventando metallico. Inoltre, essendo il procedimento di ossidazione eseguito manualmente, ogni articolo è unico.

The continuous research and development leads MYYOUR to discover new horizons. The different concept becomes different finishing: MYYOUR presents the "oxidized" in the copper and rust colors.

The careful manufacturing, which puts in symbiosis two materials clearly poles apart, involves the use of iron particles as a coating, whose oxidation process is activated by specific products and stopped by a special transparent varnish which allows the outdoor use. In this way the plastic material transforms its nature becoming metal, it is evident in the fact that a magnet is attracted to it. Since this is a purely manual processing, makes each item different and unique.

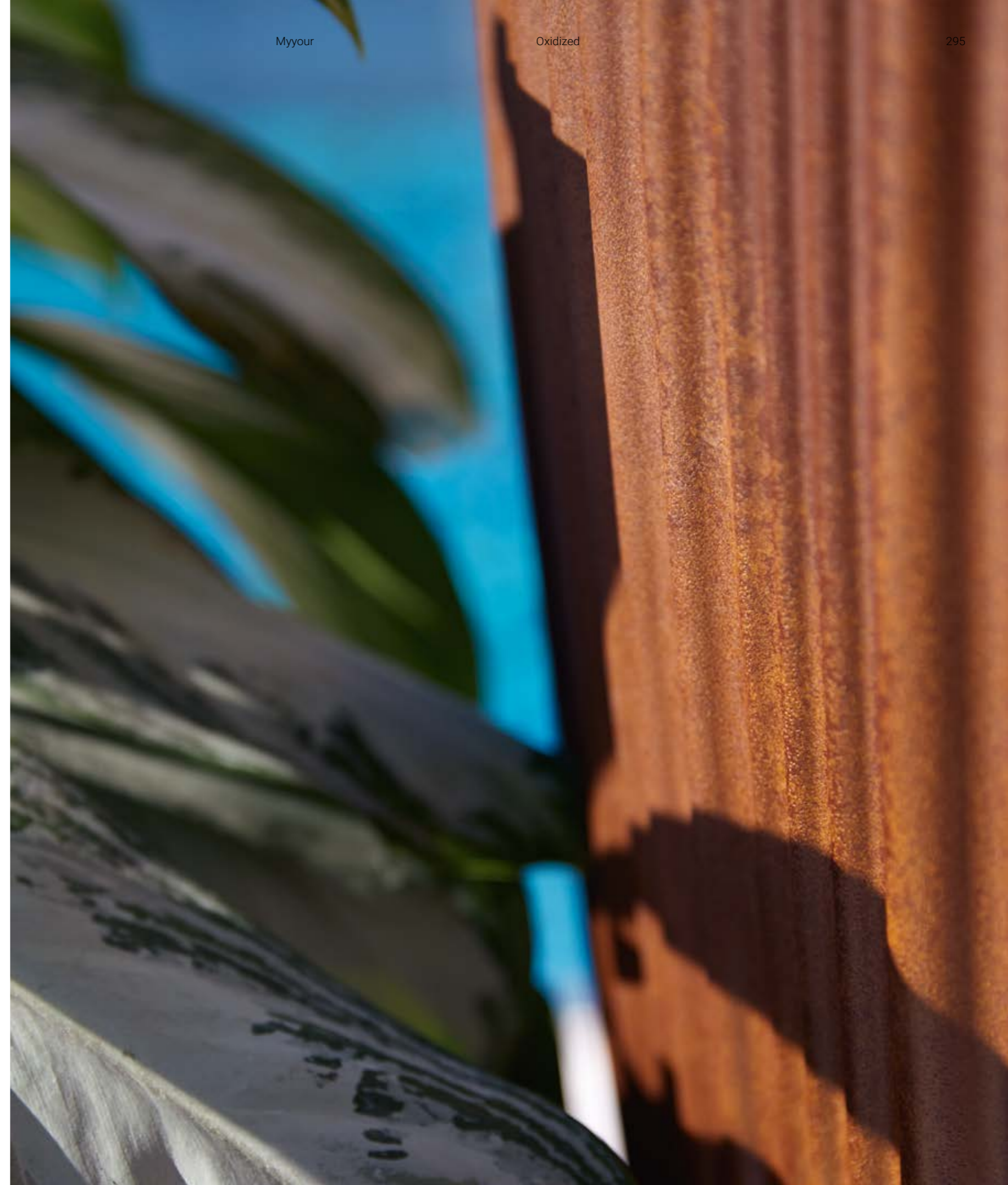



Bancone bar Dublin nella finitura ossidata rame OS
Dublin bar counter in OS copper oxidized finishing

Sgabello Oxford
Oxford stool



Vaso Skin L nella finitura ossidato rame OS
Skin L pot on OS copper oxidized finishing



Lampade Funnel L nella finitura ossidato ruggine e rame OS - catalogo luci
 Funnel L lamps in OS rust and copper oxidized finishing - Lights index

Penelope nella finitura ossidato rame OS
 Penelope in OS copper oxidized finishing



Base Modi nella finitura ossidato ruggine OS
 Modi base in OS rust oxidized finishing

Lampada Agata piantana nella finitura ossidato rame VP - catalogo luci
 Agata standing lamp in VP copper oxidized finishing - ligths catalogue



DIRECT PAINTING

Un velo che maschera la sua vera identità. Una verniciatura speciale, applicata direttamente sulla superficie del prodotto, che permette di perdere la percezione della plastica e rendendolo così prezioso alla vista e al tatto. Ogni singolo prodotto realizzato con questa finitura infatti, conserva la sua naturale matericità rimanendo esteticamente al passo con le tendenze del momento.

A veil that masks his true identity. A special painting applied directly on the surface of the product, which allows the loss of the plastic perception and makes it so precious to the eyes and touch. In fact, every single product made with this finish retains its natural materiality, remaining aesthetically in line with the trends of the moment.





Lampade Hollywood - catalogo luci
Hollywood standing lamps - lights catalogue



Vasi Gem S e vasiera nella finitura direct painting OV
Gem S and plant box pots in OV direct painting finishing

Lampade Hollywood piantana nella finitura direct painting OV - catalogo luci
Hollywood standing lamps in OV direct painting finishing - lights catalogue



Sgabelli Bart nella finitura direct painting OV
Bart stool in OV direct painting finishing



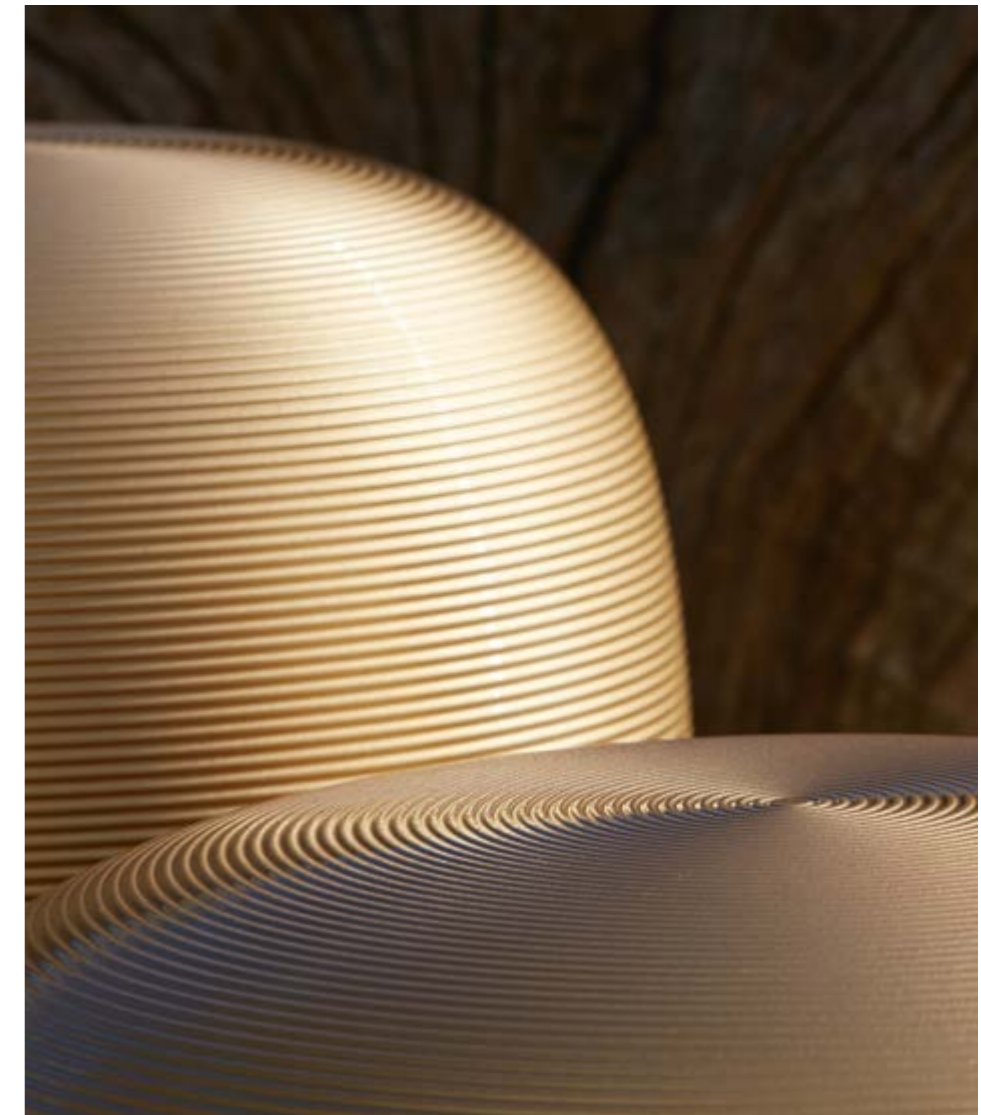

Pandora pouf nella finitura direct painting OV
Pandora pouf in OV direct painting finishing

DRY FEEL

Caratteristiche tecniche

- Asciugatura più veloce rispetto a una tradizionale schiuma per imbottitura (fino 3 volte di più).
- Riduzione dei tempi di asciugatura di un cuscino finito fino al 50%
- Maggiore durata, anche dopo immersione in acqua di mare o di piscina
- Protezione integrata contro batteri e muffe

Dryfeel® è un tipo diverso di schiuma specificatamente studiata per applicazioni da esterno, dove il rischio di umidità è maggiore. Dryfeel® è stato progettato per offrire una struttura cellulare completamente aperta che consente all'acqua e all'umidità di passarvi attraverso in modo rapido ed efficace, assicurando il massimo confort in ogni condizione di umidità. È portante e asciuga molto più rapidamente grazie alla sua struttura cellulare estremamente porosa. Le sue celle completamente aperte permettono un completo drenaggio dell'acqua, riducendo significativamente i tempi di asciugatura, pur mantenendo tutte le sue caratteristiche. È trattato con biocidi che distruggono gli organismi nocivi quali batteri, muffe e funghi.

Technical features

- Faster drying than a traditional padding foam (up to 3 times more).
- Reduction of drying times of a finished cushion up to 50%
- Longer life, even after immersion in sea or pool water
- Integrated protection against bacteria and molds

Dryfeel® is a different type of foam specifically designed for outdoor applications, where the risk of humidity is higher. Dryfeel® has been conceived to offer a completely open cellular structure that allows water and moisture to pass through quickly and effectively, ensuring maximum comfort in all conditions of humidity. It is load-bearing and dries much more quickly thanks to its extremely porous cellular structure. Its fully open cells allow complete drainage of the water, significantly reducing the drying time, while maintaining all its characteristics. It is treated with biocides that destroy harmful organisms such as bacteria, molds and fungi.



NOVA

Misure H75 x L75 x W76 cm
Measures

Altezza seduta H40/45 cm
Seat height

Finiture GS IL OV
Finishing

Imbottitura DryFeel
Padding

Rivestimento TE
Upholstery

Luce 1x E27, 1x RGBW cable rechargeable
Light

No luce
No light

Misure H75 x L150 x W76 cm
Measures

Altezza seduta H40/45 cm
Seat height

Finiture GS IL OV
Finishing

Imbottitura DryFeel
Padding

Rivestimento TE
Upholstery

Luce 2x E27, 2x 3,8w RGBW cable rechargeable
Light

No luce
No light

Misure H140 x L175 x W93,5 cm
Measures

Altezza seduta H40/45 cm
Seat height

Finiture GS IL
Finishing

Imbottitura DryFeel
Padding

Rivestimento TE
Upholstery

Luce 2x E27, 2x 3,8w RGBW cable rechargeable
Light

No luce
No light

Misure H75 x L150 x W76 cm
Measures

Finiture GS LV IL OV TE
Finishing

Luce 1x E27, 1x RGBW cable rechargeable
Light

Nova poltrona
Nova armchair

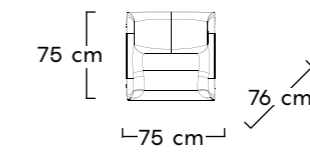

Nova poltrona imbottita
Nova padded armchair

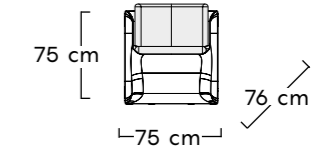

Nova divano S
Nova S sofa

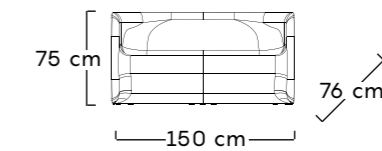

Nova divano S imbottito
Nova S padded sofa

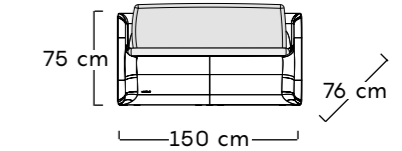

Nova divano
Nova sofa

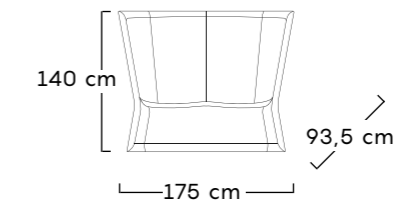

Nova divano imbottito
Nova padded sofa

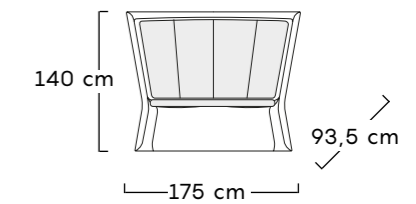

Tavolo 2054
2054 table

NOVA DIVANO S / POLTRONA
Abbinamenti possibili
Possible combination

GS - Struttura
Structure

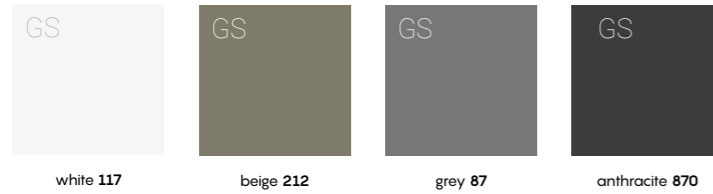

TE - Tessuto
Textile

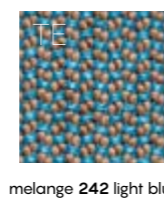
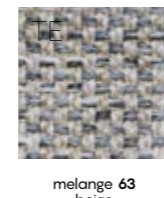

NOVA DIVANO S / POLTRONA
Abbinamenti possibili
Possible combination

OV - Struttura
Structure



TE - Tessuto
Textile

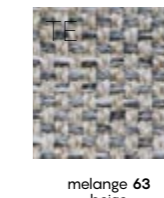
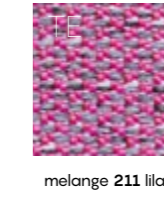

MODI ZERO

Elementi Modi Modi Elements

Modi Base, Seat, Arm, Glass top

Modi base H33 x L83 x W62 cm Modi base

Finiture GS LV OS Finishing

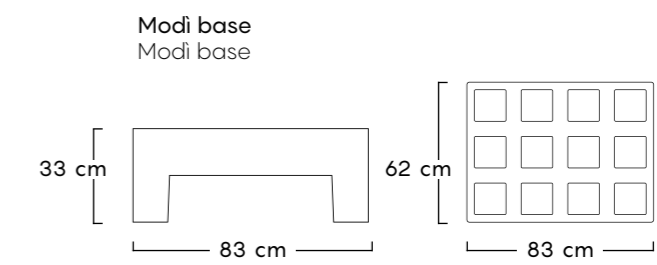

Modi pouf H12 x L21 x W21 cm Modi pouf

Finiture EVA Finishing

Modi pouf Modi pouf

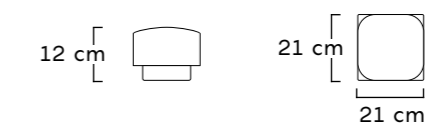

Modi schienale H45 x L33 x W21 cm Modi backrest

Finiture EVA Finishing

Modi schienale Modi backrest

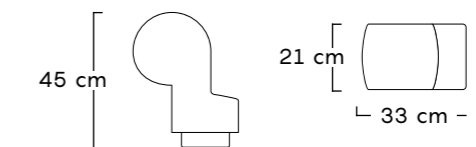

Elementi Modi zero
Modi zero Elements

- 1x Modi base
- 1x Glass top

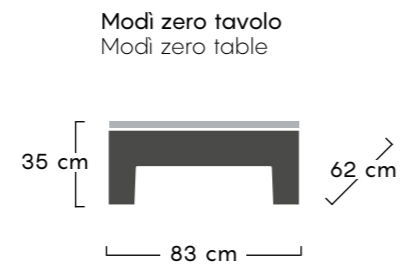

Elementi Modi zero
Modi zero Elements

- 1x Modi base
- 12x Modi pouf

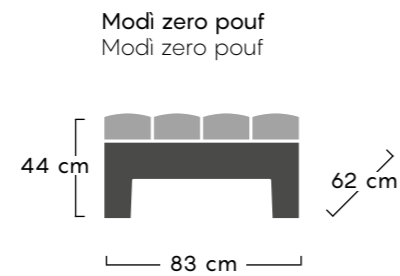

Elementi Modi zero
Modi zero Elements

- 1x Modi zero base
- 8x Modi zero pouf
- 6x Modi zero backrest

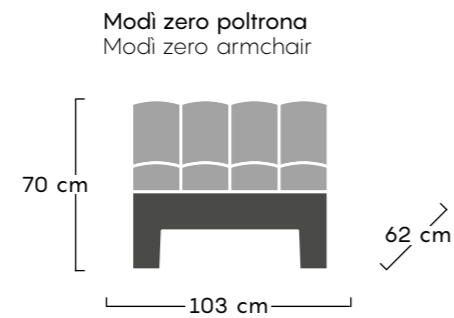

Elementi Modi zero
Modi zero Elements

- 2x Modi zero base
- 16x Modi zero pouf
- 10x Modi zero backrest

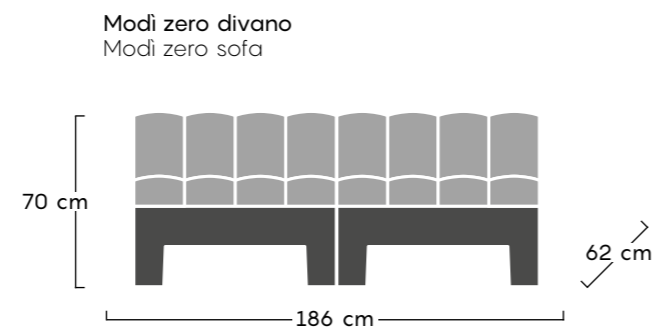

Elementi Modi zero
Modi zero Elements

Modi zero Base, Seat, Backrest, Glass top

Modi zero
Modi zero



Gli elementi del divano Modi Zero sono resistenti alla pioggia
Modi Zero's elements are rainproof

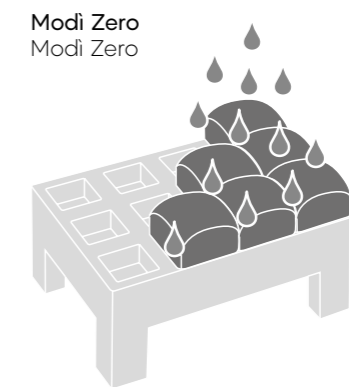

ModiZero si possono comporre all'infinito
ModiZero's have unlimited compositions

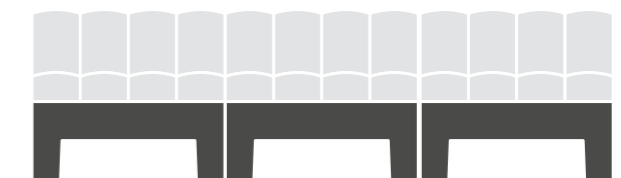

NOVA DUB LIN

Misure H110 x L100 x W770 cm
Measures

Finiture GS LV OS IL
Finishing

Cocktail station ABS
Cocktail station

Nova - Dublin Lineare con cocktail station
Nova - Dublin Straight with cocktail station

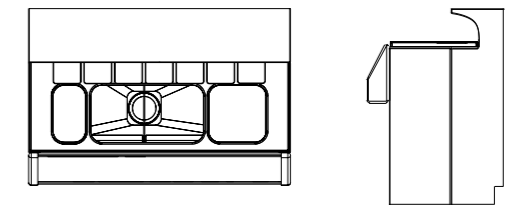

Misure H110 x L100 x W65 cm
Measures

Finiture GS LV OS IL
Finishing

Luce 2x E27 32W
Light **RGBW Led Strip,**
RGBW Cable Rechargeable

No luce
No light

Dublin Lineare
Dubling Straight

Nova Lineare
Nova Straight

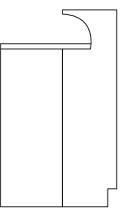
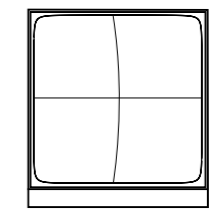
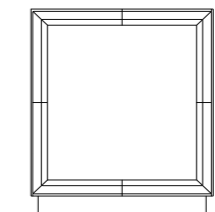

Misure H110 x L90 x W65 cm
Measures

Finiture GS LV OS IL
Finishing

Luce 2x E27 32W
Light **RGBW Led Strip,**
RGBW Cable Rechargeable

No luce
No light

Dublin Angolare
Dublin Corner

Nova Angolare
Nova Corner

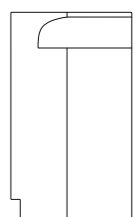
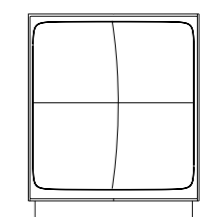
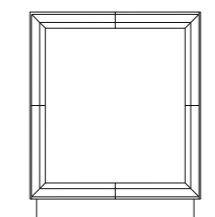

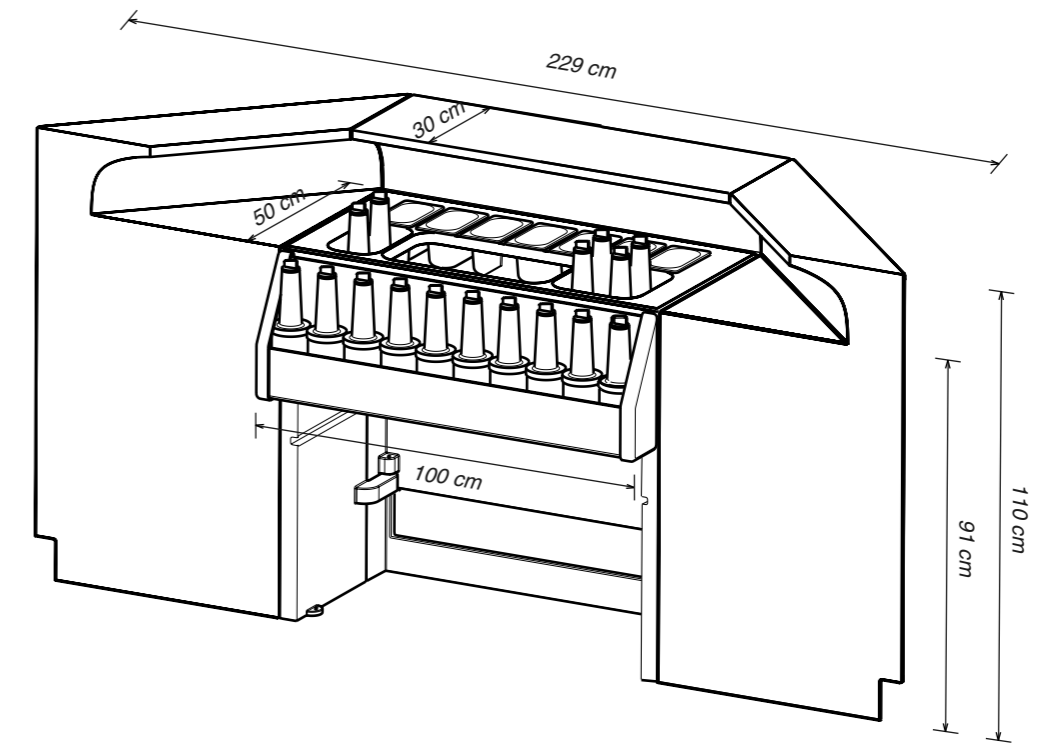
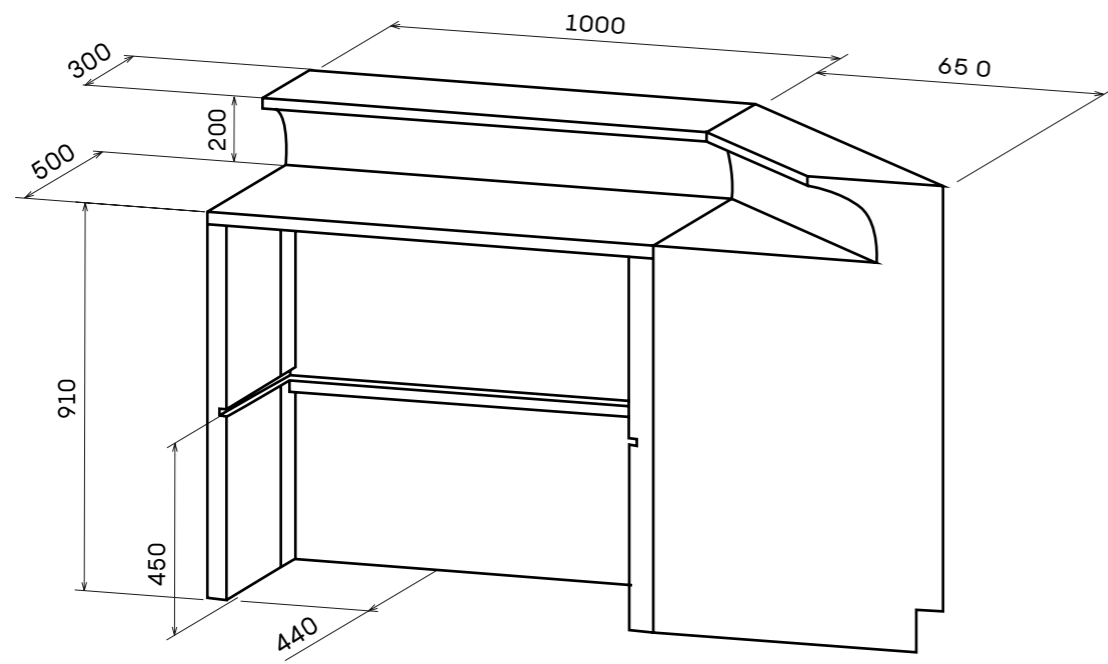

Cocktail station M

Cocktail station M

Cocktail station

- Realizzata in 2 componenti in ABS PMMA alimentare facile da pulire.
- Installazione con aggancio rapido sia su Nova e Dublin.
- Installabile ad incasso a piano.
- Vasca ghiaccio con capienza fino a circa **60 kg**.
- Separatore amovibile per ghiaccio a cubetti o spezzato.
- Piletta di scarico.
- 7 vani per vaschette H100 x L108 x W176 cad.*
- 2 vani portabottiglie interni vasca (2 + 4).*

Speed rack

- Realizzata in ABS PMMA alimentare facile da pulire.
- Elemento removibile.
- Portata fino a 10 bottiglie.*

*Vaschette e bottiglie non fornite.

**Cocktail station**

- Made of 2 components in food-grade PMMA ABS easy to clean.
- Installation with quick release both on Nova and Dublin.
- It can be installed recessed in a worktop.
- Ice tank with capacity up to about 60 kg.
- Removable separator for ice in cubes or minced.
- Drainage pipe.
- 7 compartments for bowls H100 x L108 x W176 each *
- 2 internal bottle rack compartments (2 + 4). *

Speed rack

- Made of food-grade PMMA ABS easy to clean.
- Removable element.
- Capacity up to 10 bottles. *

*Bowls and bottles not included

Cocktail station M componente vasca

Cocktail station M component box

Rimuovendo il coperchio della cocktail station si può utilizzare la sola vasca portaghiaccio sfruttando al massimo la sua capienza fino a 80 Kg.

Removing the cocktail station lid, you can only use the tank making the most of its capacity up to 80 Kg.



Sistema di montaggio
Assembling System

- 1 - Aprire le due ante
Open the two sides
- 2 - Inserire il piano
Insert the top
- 3 - Inserire la mensola
Insert the shelf

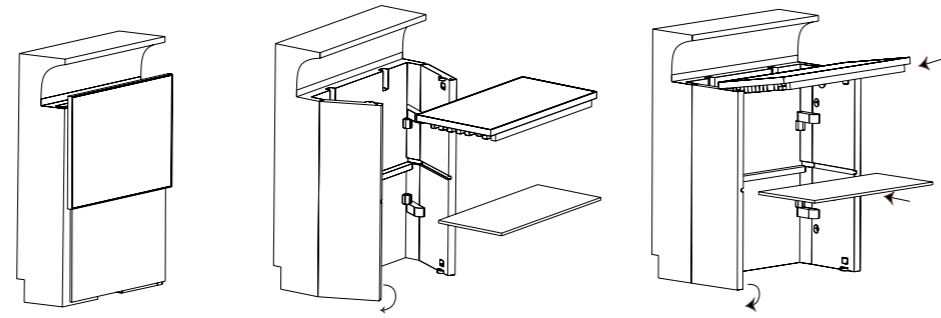

Volume trasportabile 20m³ corrispondenti a 60 moduli Nova o Dublin lineare
Volume 20m³ correspond with 60 Nova or Dublin straight

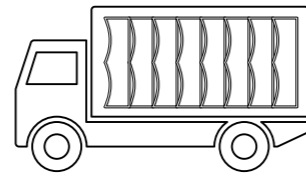

Elemento Frontale Personalizzabile
Customizable Frontal Panel

Disponibile solo per Dublin
Available only for Dublin

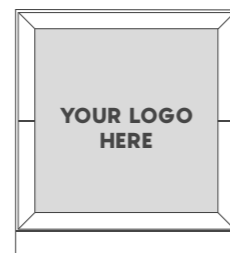

RGBW strip led

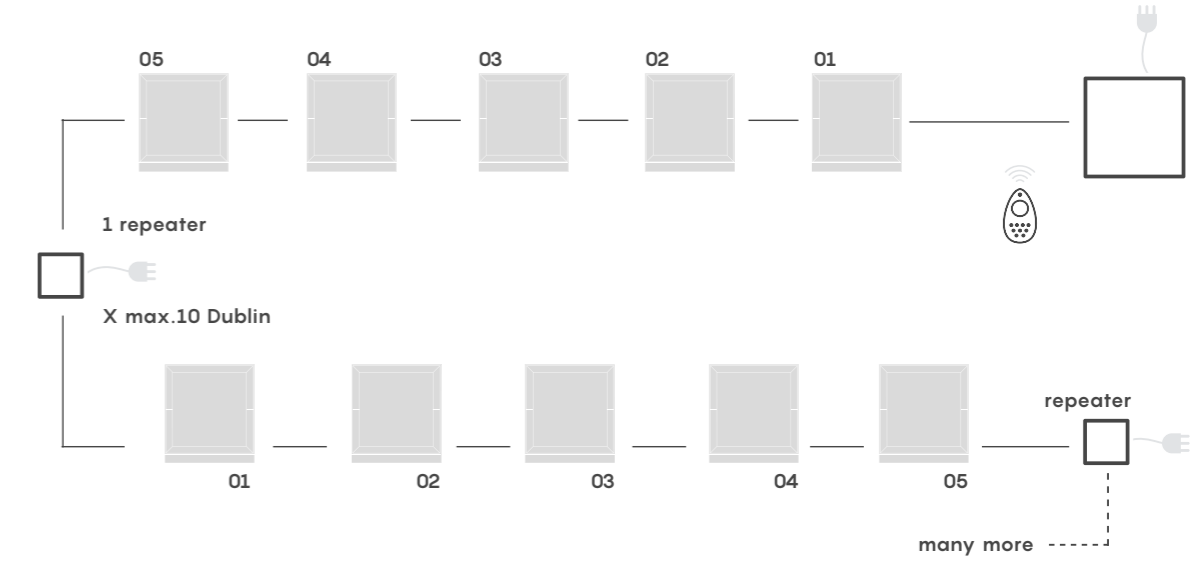

E27 lights

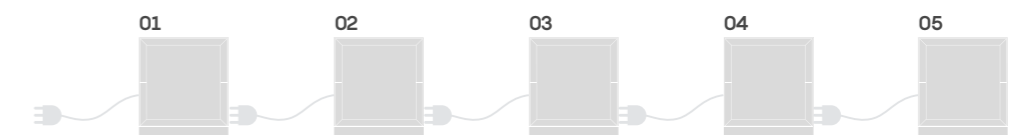

RGBW on battery rechargeable

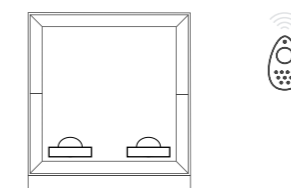

BAR AONDA NDA

Misure H110 x L90 x W90 cm

Measures

Finiture GS LV OS IL

Finishing

Luce 2x E27 32w RGBW System, White Led Strip Light

No luce
No light

Misure H110 x L160 x W33+57 cm

Measures

Finiture GS LV OS IL

Finishing

Luce 2x E27 32w RGBW System, White Led Strip Light

No luce
No light

Misure H110 x L90 x W90 cm

Measures

Finiture GS LV OS IL

Finishing

Luce 2x E27 32w RGBW System, White Led Strip Light

No luce
No light

Baraonda cocktail station Baraonda cocktail station

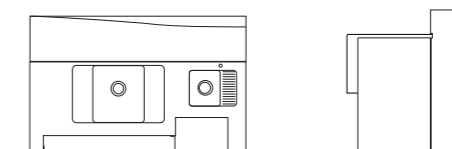

Baraonda 60 Baraonda 60

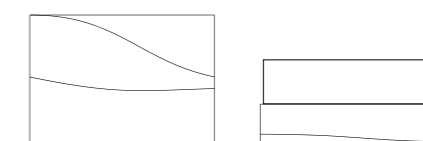

Baraonda Curva 60 Baraonda Corner 60

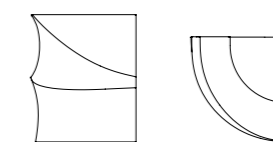

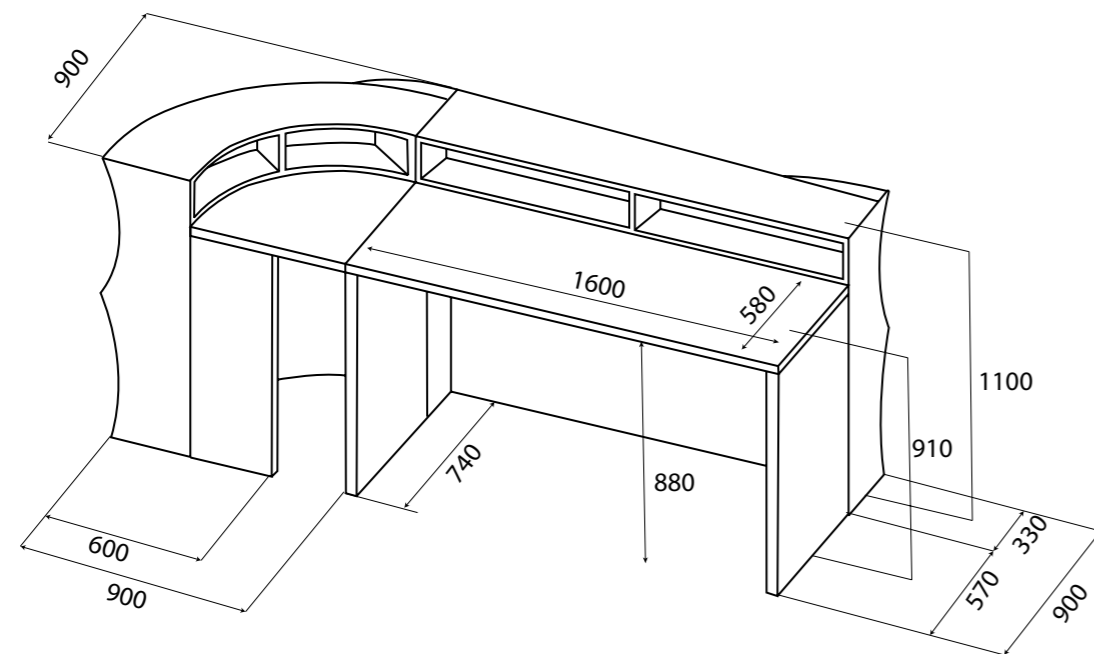

Optional Frigo con motore integrato o remoto

Fridge with integrated or remote engine optional



Optional Tapparella

Curtain optional



Optional Cocktail station

Cocktail station optional



Foto a sinistra

Picture on left page

Baraonda Composizione Bar Luce RGBW

Baraonda a Bar Composition RGBW Light System

6 Baraonda Front, 4 Baraonda Corner,
1 Baraonda Cocktail, 1 Display shelves,
1 Wireless Controller, 2 Repeater
Optional: 1 Fridge + 1 Roll-up shutter

**Presca Shuko versione
Led bianco**
White led
Shuko plug version



**Optional
Kit ruote con freni**
Wheels with brake optional



**Optional
Mensole**
Shelf optional



Sequenza montaggio - modulo chiuso
Assembling sequence - closed module



Sequenza montaggio - apertura fianchi
Assembling sequence- side opening



Sequenza montaggio - inserimento piano e mensola
Assembling sequence - top and shelf positioning



Specifiche per trasporto
Baraonda transport specs

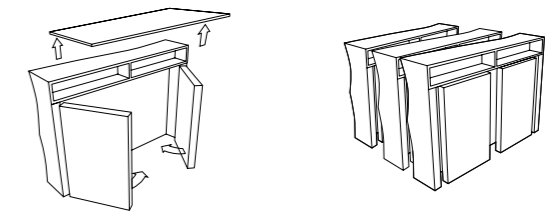

Volume trasportabile 20m³ corrispondenti a 30 moduli Baraonda dritto
Volume 20m³ correspond with 30 Baraonda straight

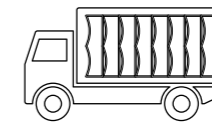

RGBW System

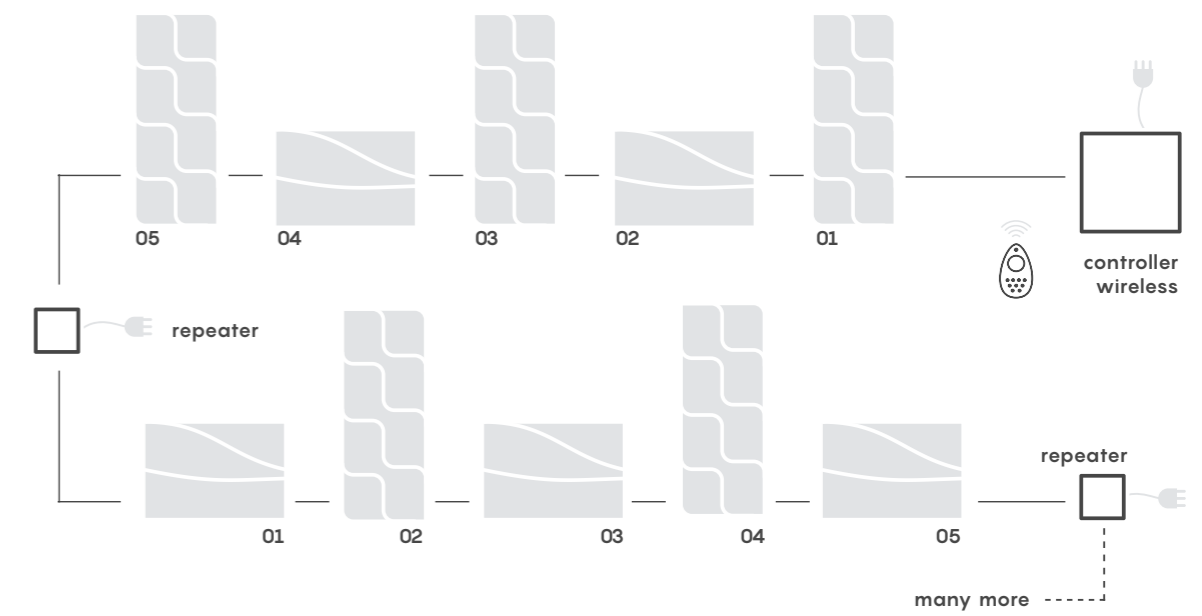



Baraonda Desk Composition 01
Glossy enamelled finishing.

1 Baraonda Front, 2 Baraonda Corner,
1 Top 70, 2 laminate side panels

KITE

Misure H350 x L300 x W300 cm, diametro 15 cm
Measures

Struttura in alluminio e acciaio verniciato bianco
copertura in pvc
White painted aluminum and steel structure
with pvc ceiling

Piastre portanti necessarie
Self Supporting plates needed

Kite 3x3
Kite 3x3

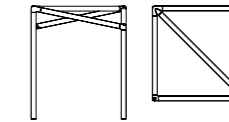

Misure H350 x L400 x W400 cm, diametro 15 cm
Measures

Struttura in alluminio e acciaio verniciato bianco
copertura in pvc
White painted aluminum and steel structure
with pvc ceiling

Piastre portanti necessarie
Self Supporting plates needed

Kite 4x4
Kite 4x4

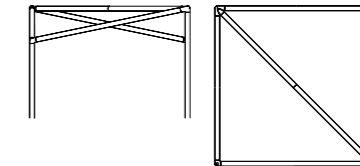

Misure H350 x L500 x W500 cm, diametro 15 cm
Measures

Struttura in alluminio e acciaio verniciato bianco
copertura in pvc
White painted aluminum and steel structure
with pvc ceiling

Piastre portanti necessarie
Self Supporting plates needed

Kite 5x5
Kite 5x5

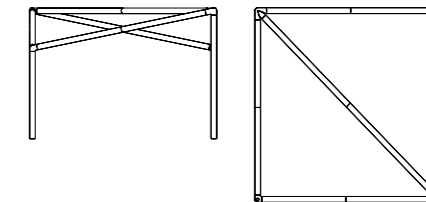

Misure H350 x L600 x W600 cm, diametro 15 cm
Measures

Struttura in alluminio e acciaio verniciato bianco
copertura in pvc
White painted aluminum and steel structure
with pvc ceiling

Piastre portanti necessarie
Self Supporting plates needed

Kite 6x6
Kite 6x6

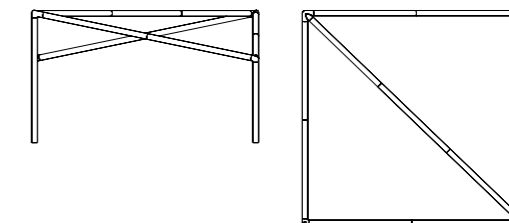



Piastra di fissaggio
Fixing Plate

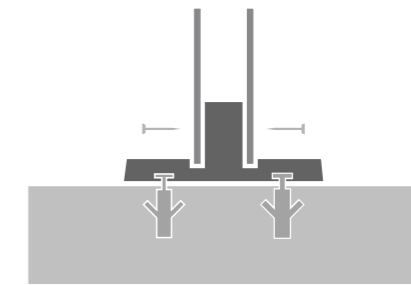

Caratteristiche
Features

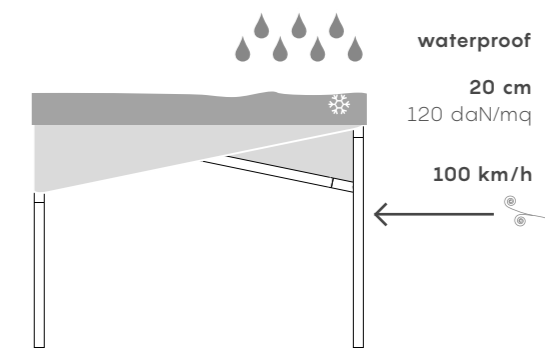

Composizioni
Compositions

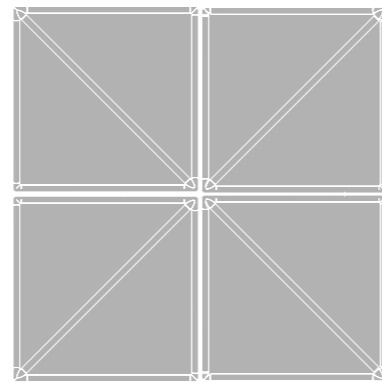
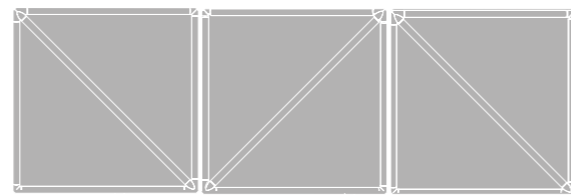
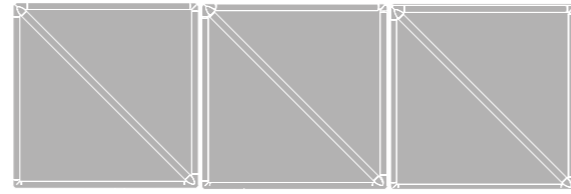

BAGIGIO

Misure H28,5 x L91 x W31 cm
Measures

Finiture GS LV IL
Finishing

Luce White Led Strip
Light

No luce
No light

Misure H28,5 x L30 x W30 cm
Measures

Finiture GS LV
Finishing

No luce
No light

Misure H28,5 x L30 x W18 cm
Measures

Finiture GS LV
Finishing

No luce
No light

Elemento Ba Gigio
Ba Gigio Element

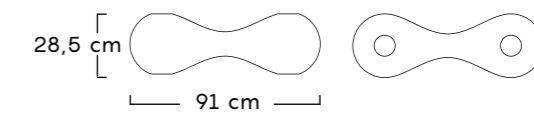

Elemento Gigio
Gigio Element

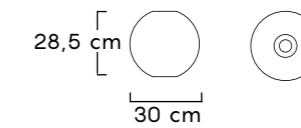

Elemento Nocciolina
Nocciolina Element

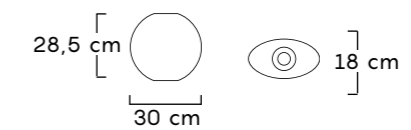

Misure H01 x diametro 50 cm

Measures

Finiture metallo verniciato bianco

Finishing white painted metal

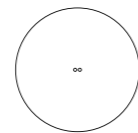
Base autoportante
Self-supporting base

50 cm

Misure H01 x diametro 9,5 cm

Measures

Finiture acciaio Inox

Finishing stainless steel

Piastra fissaggio
Fixing plate

9,5 cm

Misure H3 x L57-344 cm

Measures

Finiture metallo

Finishing metal

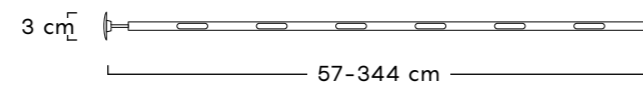
Tubo
Tube

3 cm

57-344 cm

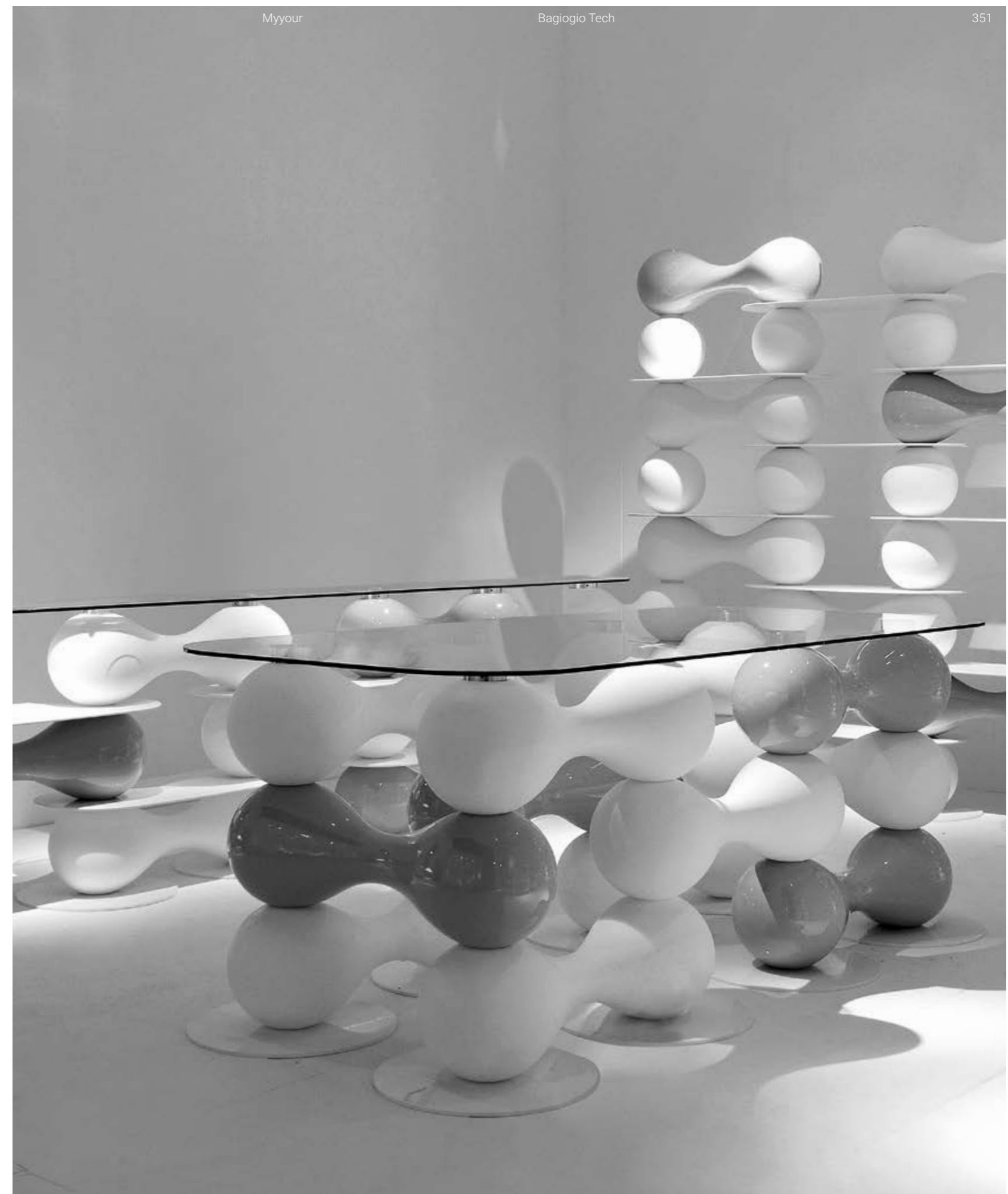

Fissaggio Ba_Gigio
Ba_Gigio Fixing

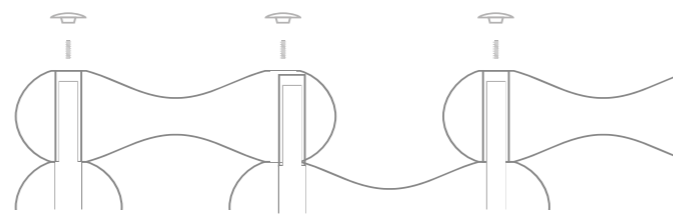

Fissaggio Piano Ba_Gigio
Ba_Gigio Top Fixing

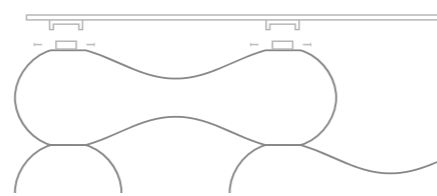

Parete Ba_gigio illuminata
Lighted Ba_gigio Wall

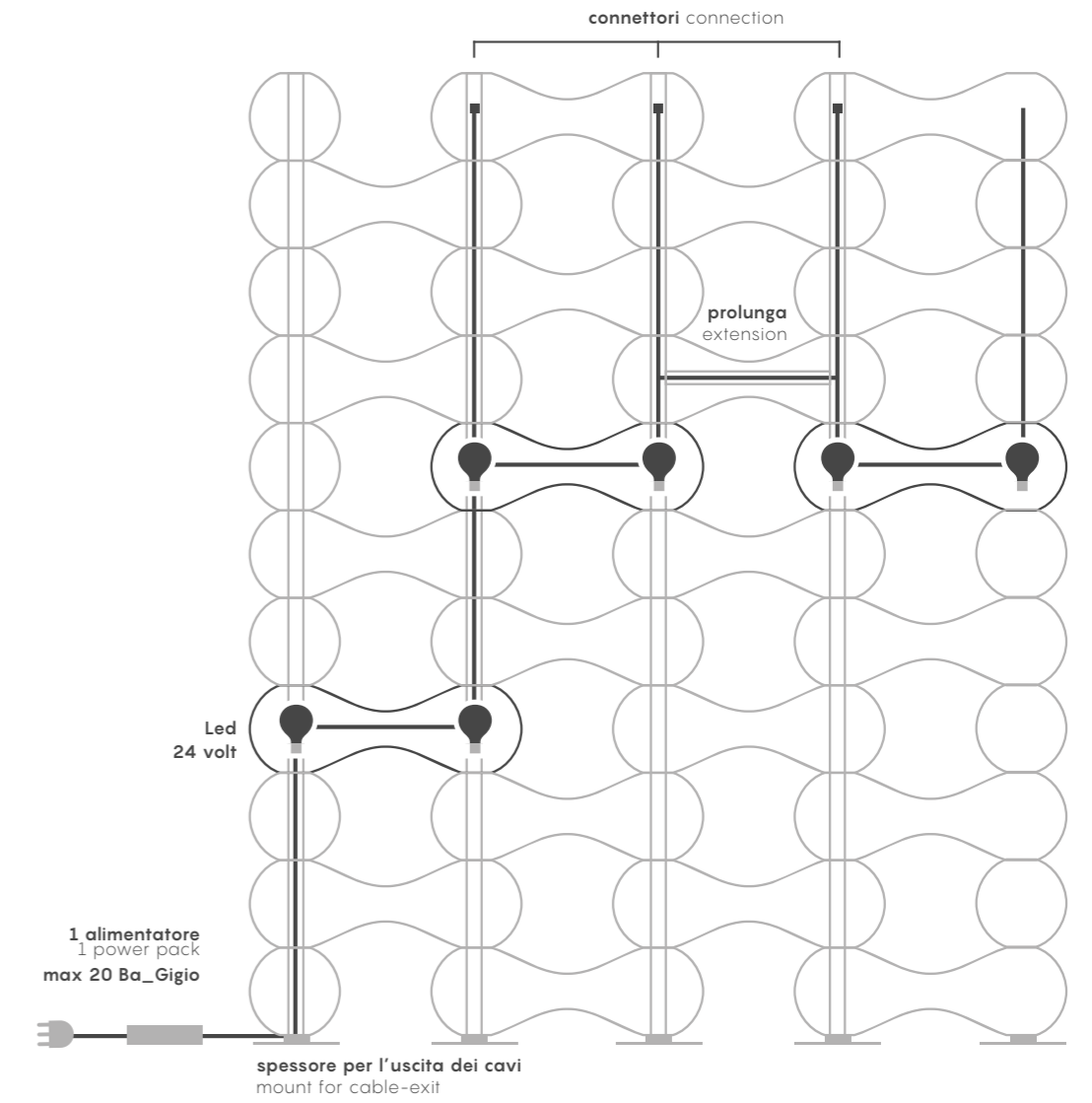

BASIC



GS white 117	GS ivory 602	GS beige 804	GS beige 212	GS beige 212
GS yellow 612	GS orange 388	GS brown 92		
GS red 550	GS marsala 759	GS lilac 404		
GS light blue 5513	GS light blue 840	GS green 662		
GS light gray 617	GS gray 87	GS black 210	GS anthracite 84 NEW	

Per conoscere i colori disponibili di ogni articolo consultare il listino prezzi.
 To know the available colours for each items, please check the price list.

DIRECT PAINTING



pink 3380



gold 52



light blue 150

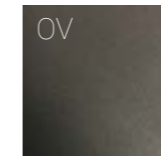

graphite 9405



pearl gray 180



dark pearl 162



pearly copper 177

Per conoscere i colori disponibili di ogni articolo consultare il listino prezzi.
 To know the available colours for each items, please check the price list.

OXIDIZED

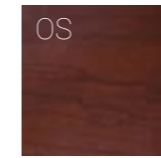

rust 500

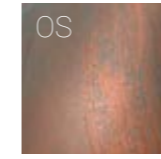

copper 101

Per conoscere i colori disponibili di ogni articolo consultare il listino prezzi.
 To know the available colours for each items, please check the price list.

GLOSSY

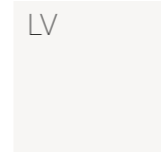

LV

white 117

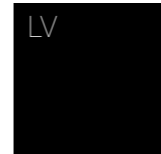

LV

black 210

Per conoscere i colori disponibili di ogni articolo consultare il listino prezzi.
To know the available colours for each items, please check the price list.

TEXTILE

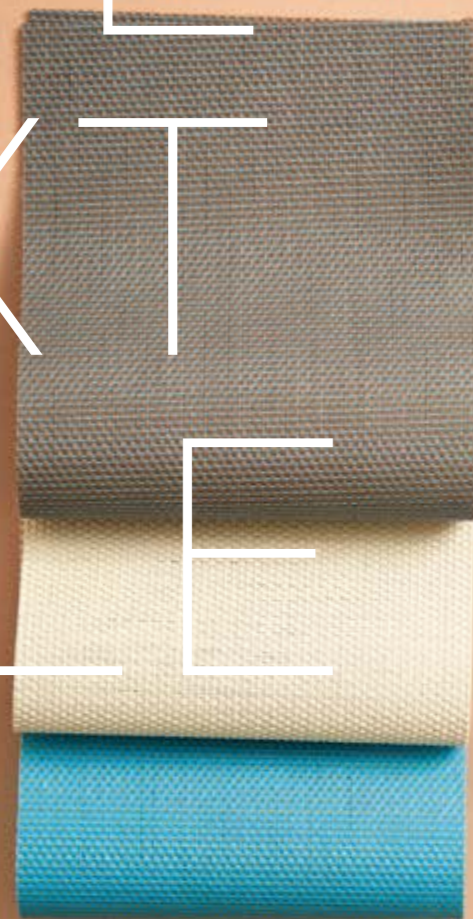

ivory 5161



light blue 4039

Disponibili solo per 2054 imbottito
Available only for upholstered 2054



ice 3966



gray 3737

Disponibili solo per cuscino Nova Lettino
e cuscini Lily
Available only for Nova sunbed pillow
and Lily pillow

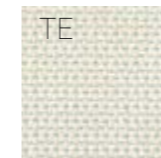

melange 02 white



melange 63 gray



melange 211 lilac

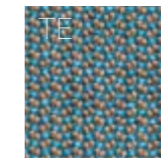

melange 242 light blue

Disponibili solo per Nova S Divano
e poltrona imbottiti
Available only for Nova S upholstered sofa
and armchair

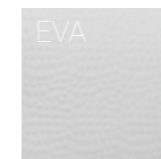

glazed grey 1050

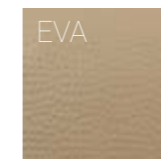

sand 1051

Disponibili solo per Modi Zero
Available only for Modi Zero

DESIGNERS

BROGLIATO TRAVERSO

About

Alberto Brogliato and Federico Traverso founded BrogliatoTraverso design studio in 2014. Their approach to design is 'NO TIME, NO SPACE' and refers to ideate objects with a timeless design. BrogliatoTraverso work by creating a detailed sign, but almost invisible. With these finely hinted forms, their creations establish deep intimate empathy with the users and their surroundings, respecting both of them. Their fine simplification process delivers projects addressing the needs of consumers and made for various companies, including Cappellini, Fratelli Guzzini, Infiniti, Il Fanale/Torremato, MyYour. The Studio won many international awards, including the Red Dot Design Award, German Design Award, iF Design Award and Good Design Award.

Products

Frames
Nova
Oxford
Dublin
Pandora family
Ampoule



CROUS CALOGERO

About

CrousCalogero is a product design consultancy founded in 2009 by Francesc Crous and Alessandro Calogero after a decennial experience side by side with famous designers and inside big companies design departments. They explain their method as follows: "Our way of working is simple: we try to get to the essence of things, eliminating what is superfluous, always with a focus on the human being. We don't like 'sculptural' objects, to admire from a distance. We want our objects to transmit a desire to be touched. Functional quality is a basic requirement we take for granted. On top of it we try to suggest a story, made of memories or sensations, to create that impalpable link between objects and people." In recent years they strengthen their collaboration with different international design firms. Alongside their professional activity they also teach at the design school EINA in Barcelona.

Products

Creazy head



ISABELLA LOVERO

About

Industrial Designer since 2004, work for several brands, including Vimar, Infiniteplay, Myyour, Morellato, Midj. In 2007 she founded the en&is studio with Enrico Bosa, defining her personal poetics by creating new types of objects such as Megaphone, iphone passive amplifier, which gave life in 2011 to a startup favouring ceramics and wood.

Ever caring for to the relationship between the people and the product, and the feelings that it evokes, from 2013 she design from the electronic devices to accessory project to the furniture. She teach to led, European Institute of Design sience 2016 and she is Art Director of Infiniteplay.

ENRICO BOSÀ

About

Industrial Designer since 2007, he work for Stefano Giovannoni studio designing for Magis, Alessi, Deborah. In 2007 he founded the en&is studio with Isabella Lovero which gave life in 2011 to a startup favouring ceramics and wood with Megaphone.

He is Associate Creative Director for Marcell Wanders studio of industrial design department

Products

Skin
Tino



MASSIMO ZANIBONI

About

Massimo Zaniboni graduated with honors in 1994 at the Polytechnic of Milan with a specialization in Industrial Design. He matures her first professional experiences as a designer employed by the Piaggio Style Center in Pontedera. Soon, Aprilia, Italjet and Kymco gave him the opportunity to pursue a free profession by involving him in several innovative scooter and motorbike projects and in advanced design activities.

In 1996 he founded Arkema Studio, a workshop able to produce in a few years different prototypes of scooters, accessories and concept bikes characterized by innovative technical and stylistic solutions that are always distinguished by a strong, very recognizable formal personality.

Products

Non vaso



MORE DESIGN

About

Moredesign, a company based in Padua founded in 2007, which deals with industrial design in line with market needs following the client's requests.

Our experience allows us to offer all the creative and design contribution to companies that want to stand out by offering multidisciplinary design.

We follow the company and the product in all its development phases by applying innovation in the forms, tightening the designer-company combination giving the guarantee of the final result.

We have worked with the most important Italian and foreign brands and our products are present and exported all over the world.

We are able to rationalize an idea and always have a lateral thinking, with a single objective: to put man and his needs at the center of every project.

Products

Modi
Lily family
Liberty
Mr Lem
Community set
Lucy & Rhonda
Miss petra
Dyno
Baraonda
Bart
Cloe
Zoe



PAOLO CAPPELLO

About

Born in 1980 in Verona.

Graduated in Industrial Design at Politecnico di Milano.

After a three years collaboration with Ludovica+Roberto Palomba in Milan, in 2007 he setup his own studio in Verona where he collaborates with other professionals in architecture, communication and graphics.

His works have been showcased in many expositions in Rome, Milan, New York, Paris, São Paulo, Miami, London and Dubai.

Paolo also collaborates with Rolling Stone magazine writing the design column for the online edition.

Paolo's works have been featured by main international magazines and newspapers as NY Times, Herald Tribune, Abitare, Interni, Ottagono, Residence, Icon, Elle Decor, Rolling Stone.

Products

Gem



ROSARIA COPETA

About

Rosaria Copeta was born in Matera in 1984, she studied at the Faculty of Architecture of the La Sapienza University of Rome, where in 2009 she obtained a Master's Degree with honors in Industrial Design and Visual Communication. She trained at the historic company Pozzi Curvati in Brianza, subsequently she worked as a professional designer in the R&D of the company Casamania by Frezza, dealing with the development of the product. She received the special mention at the competition "Young & Design Award" 2010 with the table "Lightable" and she is included in the "Class" design excellence classifications in 2011.

Products

Tao



SIMONE MICHELI

About

Simone Micheli founds firstly the architectural firm in 1990, and lately in 2003 with Roberta Colla the design company Simone Micheli Architectural Hero, with headquarters in Firenze, Milano, Puntaldia, Dubai, Rabat and Busan.

His work is carried out on many fields, ranging from architecture to interior design, passing by the product, visual and graphic design, as also online and offline communication, the organization of events; his creations, always sustainable and environmentally conscious, are characterized by a strong and unique identity. He has realized many projects for public administrations and for important private committees connected to residential world and the collectivity. Simone Micheli is curator of many thematic expositions - not just the contract ones - inside the main international architecture, design and hospitality fairs.

Moreover he is Professor at PoliDesign and at SPD - Scuola Politecnica di Design in Milan. In collaboration with Roberta Colla and her team of professionals, he holds conferences, workshops and lectures at universities, cultural institutes and many institutions all over the world.

His works were presented in the most prestigious expositions and many are published in Italian and international newspapers, magazines and periodicals.

Products

Baggio
Chips



VALERIO COMETTI + V12 DESIGN

Valerio Cometti, born in 1975, has a degree in Mechanical Engineering from the Polytechnic of Milan and in 2005 he establishes "Valerio Cometti+V12 Design".

Bringing together the sensitivity of a designer with the vision of an engineer, Cometti starts collaborating with some of the most prestigious brands in the design scene: in 2006, he looks after the re-launch of the historical brand Brionvega.

His eclectic vision brings V12 Design to collaborate with some of the most established brands belonging to very different sectors: from consumer electronics to corporate Museums, from furniture design to eyewear, from high tech wearable devices to the coffee industry.

Valerio Cometti+V12 Design works together with historical Italian brands such as LaCimbali, Bertazzoni, Ferrari and Riva1920, as well as with important international companies, helping them in a wide range of consultancies such as branding, product design, creative direction and Deep Design Thinking.

Products

2054

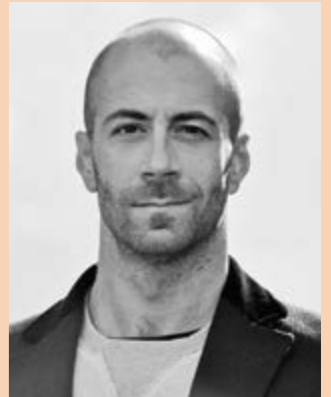

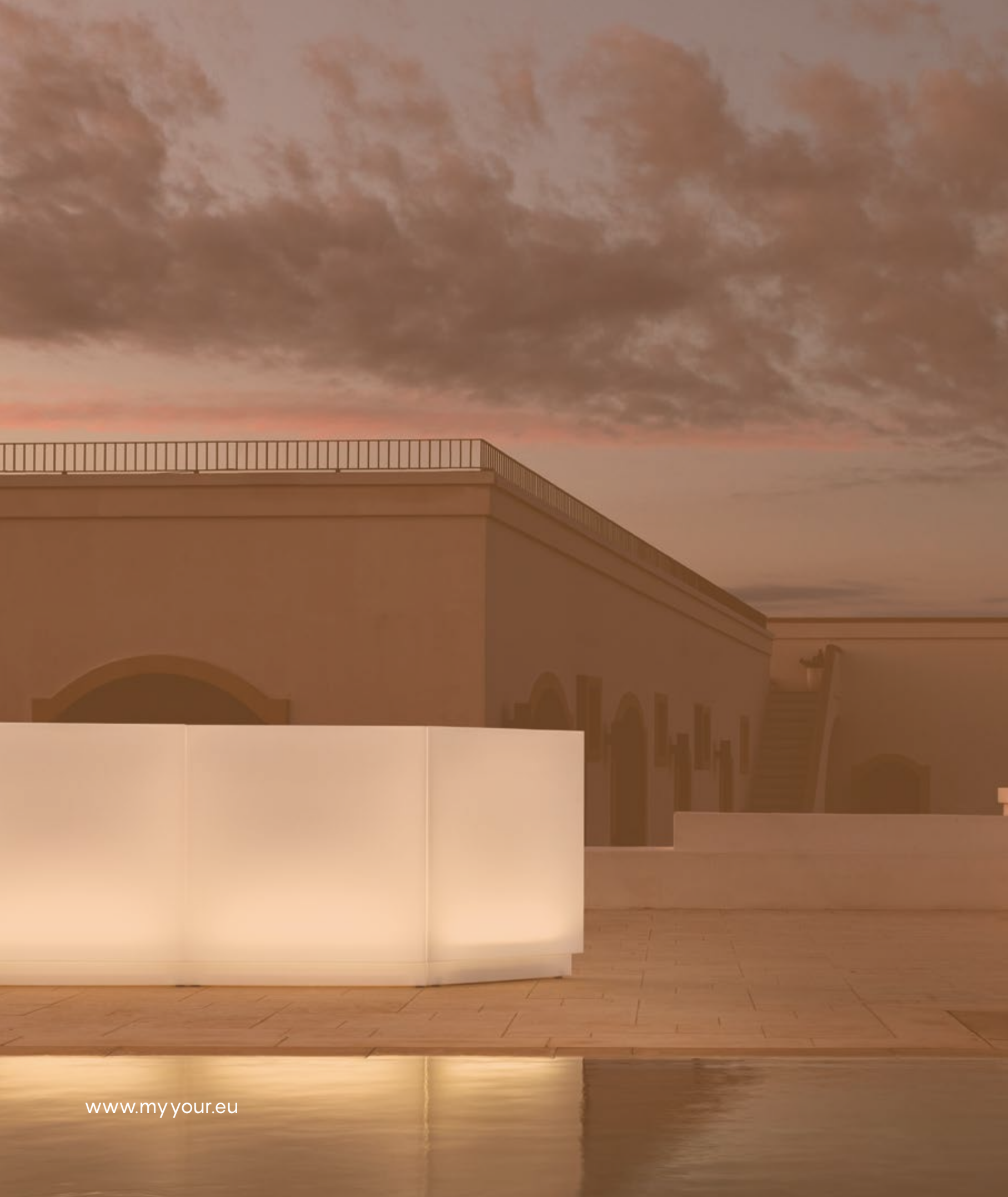

www.myyour.eu